

# CHOOSE YOUR MOTION



ROTARY



MULTI-POSITION



INDEXING



STEPPING



MULTI-MOTION



## 2026

PRODUCT GUIDE

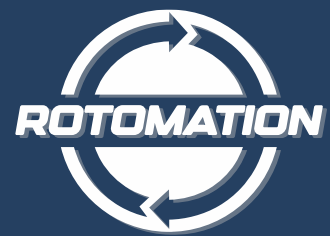

Rotary Motion For Automation

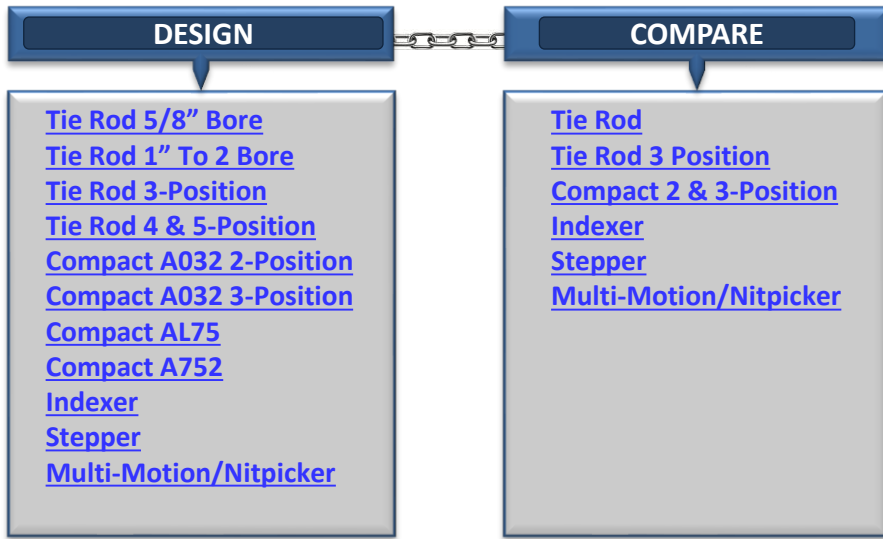

## Table of Contents

**5 ROTOMATION**  
Information about our company and how we do business

- 3) [Terms](#)
- 4) [Options Guide](#)
- 5) [Advantages/About](#)
- 6) [Seal Information](#)
- 7) [Services](#)
- 8) [Key Contacts](#)
- 9) [New & Noteworthy](#)
- 10) [ROTOcad](#)

**31 INDEXING ACTUATORS**  
Unidirectional rotation in fixed precise steps to hard stops

- 31) [Cutaway](#)
- 32) [Series Comparison](#)
- 33) [Design Your Indexing Actuator](#)
- 34) [Indexing Actuator Pricing](#)
- 42) [Indexing General & Motion Control](#)

**11 MOTION**  
The types of motion our rotary actuators produce

- 11) [Rotary Actuator Motion](#)
- 12) [Applications](#)
- 13) [Special Rotary Actuators](#)

**35 STEPPING ACTUATORS**  
Unidirectional rotation in steps without hard stops

- 35) [Series Comparison](#)
- 36) [Design Your Stepping Actuator](#)
- 37) [Stepping Actuator Pricing](#)
- 42) [Stepping General & Motion Control](#)

**14 TIE ROD ROTARY ACTUATORS**  
For applications where reliability and durability are important

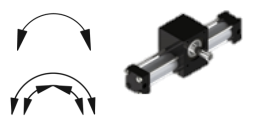

- 14) [Series Comparison](#)
- 15) [3-Position Comparison](#)
- 16) [Design Your 5/8" Bore](#)
- 17) [5/8" Bore Pricing](#)
- 18) [Design Your 1" To 2 Bore](#)
- 19) [Design Your 1" To 2" Bore 3-Position](#)
- 20) [4 & 5-Position](#)
- 21) [1" To 2" Bore Pricing](#)
- 42) [Tie Rod General & Motion Control](#)

**38 MULTI-MOTION/NITPICKERS**  
Independently-controlled linear and rotary motion & independently-controlled indexing with linear motion

- 38) [Series Comparison](#)
- 39) [Design Your Multi-Motion](#)
- 40) [Design Your Nitpicker Actuator](#)
- 41) [Multi-Motion/Nitpicker Pricing](#)
- 45) [General & Motion Control](#)

**22 COMPACT ROTARY ACTUATORS**  
High torque in a small space

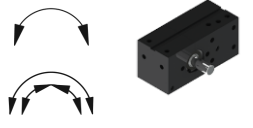

- 22) [Series Comparison](#)
- 23) [Design Your A032 2-Position](#)
- 24) [A032 2-Position Pricing](#)
- 25) [Design Your A032 3-Position](#)
- 26) [A032 3-Position Pricing](#)
- 27) [Design Your AL75](#)
- 28) [AL75 Pricing](#)
- 29) [Design Your A752](#)
- 29) [A752 Pricing](#)
- 43) [A032 2 & 3-Position General & Motion Control](#)
- 44) [AL75 & A752 General & Motion Control](#)

**46 OPTIONS**  
Additional items

- 46) [Mount Plates](#)
- 47) [Tie Rod Vent Ports](#)
- 48) [Magnetic Position Sensors](#)
- 49) [Other Signal Options](#)
- 50) [Match Your Load With Shaft](#)
- 51) [Shaft Mounting Adapters](#)
- 52) [Extreme Environment](#)

**53 REPLACEMENT PARTS & KITS**  
Parts and seal repair kits

- 53) [Replacement Parts](#)
  - 54) [Seal Repair Kits](#)
  - 55) [Repair Service & Product Warranty](#)
- 

**55 REPAIR SERVICES & WARRANTY INFORMATION**

## END CAP OPTIONS

1. The following combinations can NOT be installed on one end of a SINGLE-CYLINDER:
  - Flow control (F) and Cushion (C). Instead, order cushions and install external flow controls.
  - Bumper (Q) and Cushion (C).
2. The following combinations can be installed on one end of a SINGLE-CYLINDER:
  - Flow control (F) and rotation adjuster (A).
  - Cushion (C) and rotation adjuster (A).
  - Bumper (Q) and rotation adjuster (A). See the “Add to C” column in the dimension table.
  - Flow control (F) and bumper (Q). See the “Add to C” column in the dimension table.
  - Flow control, bumper, and rotation adjuster. See the “Add to C” column.

## MAGNETIC PISTON AND SWITCH OPTIONS

1. Magnetic control option provides switches installed and tested. Magnets are installed in pairs in rotary applications even if only one switch is specified.
2. The magnet-only option (N) provides magnets installed as above allowing later installation of switches. N option may affect dimensions of the actuator in the same way that magnetic switch options do, see Dimensions and Specs pages.
3. Switches from other sources may operate on Rotomation actuators, but the factory cannot specify which ones and CAN NOT guarantee compatibility or performance.
4. Like most suppliers of electrical components, Rotomation CAN NOT accept returned switches.

**All switches, including those sold as replacements, are tested by Rotomation prior to shipment. The user should verify circuit connections before applying power.**

## STANDARD FEATURES

All actuators are equipped with ball bearings as standard, except A1, A12, A752 with hollow shaft option (HS) and AL75 with washdown (J) option.

All standard piston seals are made of internally lubricated highly saturated nitrile (HNBR).

## REORDERS

To duplicate a product in the field, you can reference the serial or stock number. If the number cannot be read from the label, peel it off and find the number stamped into the body.

## SPECIALS

Rotomation welcomes requests for specials. Specials can save the customer parts and engineering and improve the product. We stock blanks of many parts which we can modify quickly and easily to provide the majority of simple changes, usually with no effect on lead time. More complex specials may take a little longer but are often justified. We will assign a special, simplified model number to specials to avoid confusion in reordering. We can also declare a special to be proprietary to the OEM or distributor to protect their investment.

## STOCK NUMBERS

Do our extra-long part numbers drive you crazy?

We issue a five-digit stock number for each unique actuator configuration when it is ordered. You can find it on the label and reorder using this number if desired.



## ABOUT US

Delivering engineered solutions since 1967, the Rotomation Team prides itself on providing reliable, extremely configurable, and fully rebuildable pneumatic actuators for automation.

Choose rotation options from a bidirectional rotation between two, three, four, or five positions, and unidirectional rotation in steps. Any of these rotary motions can be combined with independently controlled linear motion in a single actuator.

Our actuators are used in applications for metalworking, assembly, testing, and packaging machinery for automotive, semiconductor, food, pharmaceutical, and other industries.

## RUGGED, PRECISE, RELIABLE

When your customer cannot afford downtime, you need components that will not fail! Rotomation actuators are built to the tightest tolerances and of the toughest materials available.

## CONFIGURABLE

### DON'T LIVE WITH ONE SIZE FITS ALL

Our standard rotary actuators have billions of possible configurations. If you need help determining which type of actuator to use for your application, or the appropriate size to handle your load properly, we can help make sure the actuator you buy is the one you need.

- ✓ CONSULT WITH AN ENGINEER
- ✓ SELECT A SHAFT MOTION
- ✓ PICK A BASIC UNIT
- ✓ SPECIFY OPTIONS
- ✓ RECEIVE CAD MODEL OF UNIT AS CONFIGURED
- ✓ GET PROMPT DELIVERY

Specials? if you need a customized or custom-designed actuator beyond the standard configurations, our engineers can help you determine the best solution for your application. Send us your sketch. We will help you determine any modifications and additional parts required in order to make our actuator fit your application.

## ROTOMATION ACTUATORS ARE THE TOUGHEST AVAILABLE

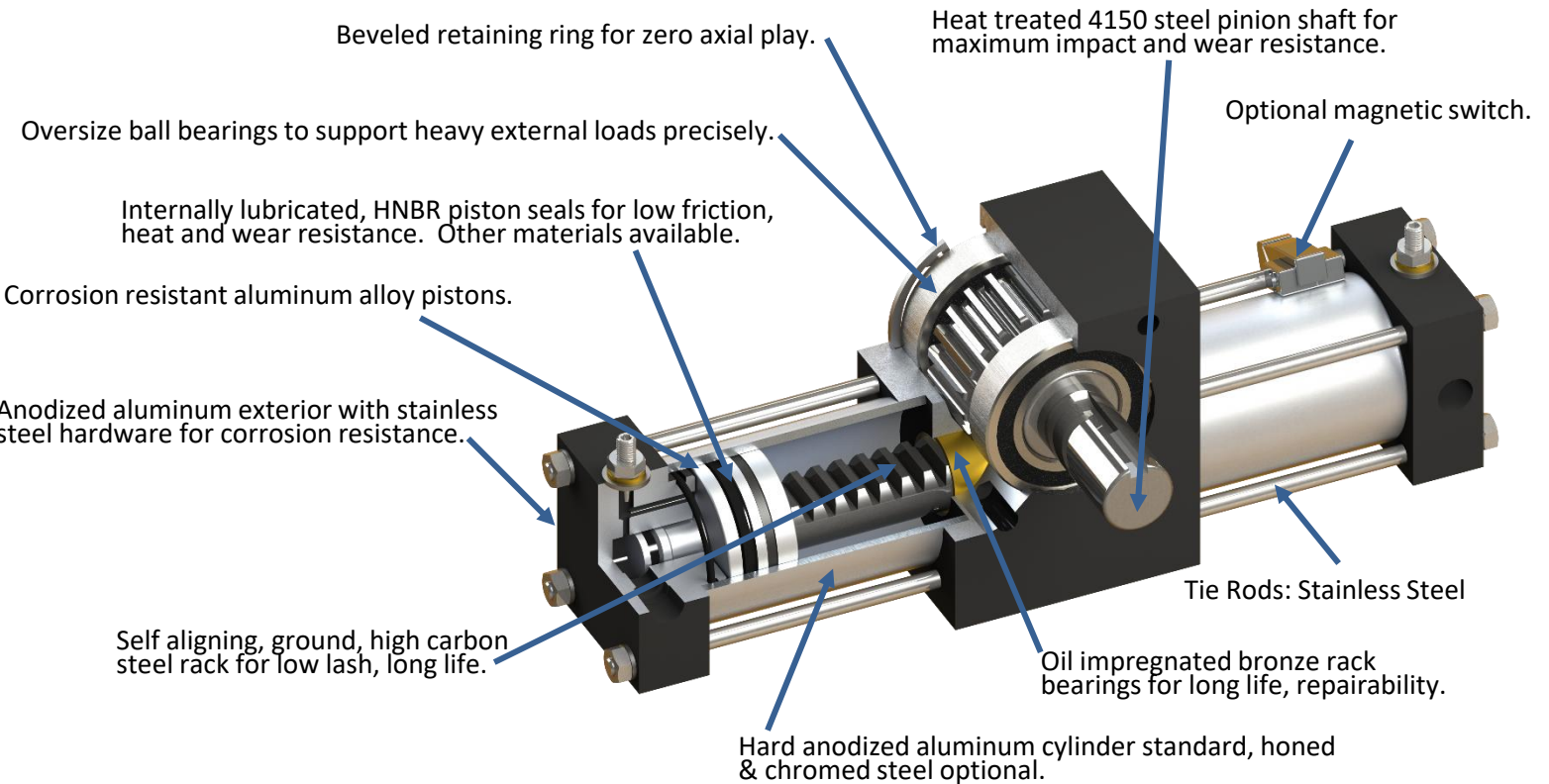

## SEAL INFORMATION FOR ROTOMATION PRODUCTS

### STANDARD AND OPTIONAL SEALS

| Option           | Piston Seals (U-Cups)                   | Static Seals(O-rings) | Symbol |
|------------------|---|-----------------------|--------|
| None             | Highly saturated nitrile                | Nitrile               | -      |
| FKM              | Fluorocarbon                            | Fluorocarbon          | V      |
| Pretensioned     | Polyurethane pretensioned (oil service) | Nitrile               | T      |
| FKM Pretensioned | Fluorocarbon pretensioned (oil service) | Fluorocarbon          | VT     |

### SHAFT SEALS FOR ACTUATORS WITH THE WASHDOWN (J) OPTION

| ACTUATOR                               | STANDARD SHAFT SEALS                             | STANDARD WASHDOWN SHAFT SEALS (OPTION J) | OPTIONAL WASHDOWN SEALS (OPTIONS V + J)       |
|--|--|--|---|
| AL75                                   | Standard sealed ball bearings (nitrile)          | Nitrile O-ring in PET plain bearing      | Fluorocarbon O ring in PET plain bearing      |
| A032, A752, A01, A1, A12, S1, PA01, S4 | Standard sealed ball bearings (nitrile)          | Not Available                            | Not Available                                 |
| A2, A22, A3, A32, A4, A42, S3, S32     | Standard sealed ball bearings (nitrile)          | PTFE shaft seals and nitrile O-rings     | PTFE shaft seals and fluorocarbon O-rings     |
| S2, X1, X2, X12, X3, X32, X4, X42      | Nitrile shaft seals                              | Nitrile shaft seals                      | PTFE shaft seals                              |
| PA2, PA22                              | Standard sealed ball bearings, nitrile rod wiper | Enclosed ball bearing, nitrile rod wiper | Enclosed ball bearing, fluorocarbon rod wiper |

[For more information:](#)



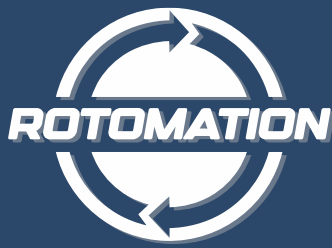

## WHAT TO EXPECT SERVICES



### DEDICATED TO YOUR SUCCESS

Rotomation is dedicated to your success, so we provide the best customer service we can. When you do business with Rotomation, you get specialized engineering services, personalized customer service, and targeted technical support.

### 5-STAR SERVICES ★★★★★



DESIGN & MANUFACTURING



CUSTOMER SERVICE & SUPPORT



QUALITY ASSURANCE



RAPID TURNAROUND



PRODUCT LONGEVITY

### TROUBLESHOOTING GUIDANCE

We will help you with any issues using our actuators with your application, guide you through critical initial steps to determine the root cause, and provide you with specific suggestions to prevent future reoccurrence. We will stand by your side until your actuator issues are fully resolved, and you're back in business.

### CAD SERVICES

Unlock the full potential of your projects with our CAD software! Effortlessly configure the actuator you need, right at your fingertips. For specials or those few products that are not included on our online CAD configurator, just let us know, and we'll create and send them to you directly.

Visit [www.Rotomation.com/cad](http://www.Rotomation.com/cad) to access the software.

### TESTING

#### QUALITY YOU CAN COUNT ON

Rotomation tests 100% of the actuators we sell before shipment to assure conformance to published ratings and specifications. If you need us to perform additional testing of any nature, we will be glad to setup special testing for your actuator. Our capabilities include, but are not limited to, performance, life cycle, and leak tests.

### PRODUCT REBUILD

#### RESTORED LIKE NEW

Rotomation actuators stand up to millions of operations under heavy load and are fully rebuildable even if the warranty expired years ago, provided the main body hasn't suffered catastrophic damage. Our technicians rebuild units in our own shop, returning your actuator to like-new operation, with a quick turnaround. Or we will supply you the parts and documentation so you can do it yourself.

If you ever have to return a product to us for repair or refund, we will resolve your return as promptly and efficiently as possible to minimize any potential impact on your operations.



386-676-6377



rotomation.com



sales@rotomation.com

| Norman Lane   | Ian Jobson  | Trish Castiglia   |
|---|---|---|
| President/Owner & Engineer  | Engineering/Marketing   | Administration  |
| Design<br>Training<br>Technical Support   | CAD<br>Design<br>Digital Marketing<br>Technical Support                         | Quotes<br>Accounting<br>Sales Inquiries<br>Billing Inquiries                        |
| 386-676-6377 x102<br><a href="mailto:norman@rotomation.com">norman@rotomation.com</a> | 386-676-6377 x104<br><a href="mailto:ian@rotomation.com">ian@rotomation.com</a> | 386-676-6377 x100<br><a href="mailto:trish@rotomation.com">trish@rotomation.com</a> |

*Rotomation has maintained a 5-Star business rating on Google. Our team strives to deliver expert customer service, and we look forward to serving you.*



 **Scott Bailey**   
7 months ago

Great product made in the USA. Highly configurable product to meet your needs, eliminating large MOQ requirements for specials. Great distributor network that can provide application support.

Hide



 **Mike Albright**   
6 months ago

Excellent company to work with, highest quality of manufacturing + prompt delivery and willing to do whatever it takes, to get the product properly suited to customers needs! Also a terrific culture with the company.

Hide



 **Harry Ellis**   
7 months ago

A great company with a great product. We've been working with Rotomation for 20+ years now and they continue to provide us with great support and customer service! Great job!

Hide



## AS7 Compact Rotary Actuator

### Rotomation's Engineers Deliver Custom Solution For AMT

Controlling drive pressure to ensure jam-free conveyance is paramount for moving empty plastic bottles at high speed between the blow molder and the filling equipment for AMT (Advanced Manufacturing Technology).

Their original solution was a safety hazard, bulky, and difficult to service and adjust.

Rotomation's solution was the AS7, a custom rotary actuator designed just for this application. The built-in directional control valve reduced the number of air lines to 1. Fixed orifices control the speed, eliminating the need for adjustment at assembly and reduced problems in the field due to user error. Built-in rotation adjustments made it easy to set. Mounting became quick and simple, with just 2 bolts, the air line, and a special lighted cable for the valve. The actuator is protected from damage by washdown and has no pinch points. The AS7 is now used for all AMT's products of this type.

Your applications are UNIQUE, so are our Actuators! We are happy to discuss your requirements and present a solution that works for you, not one you must work around.

### Simplify Production, Reduce Costs & Improve Safety



?

Air cylinder driving a lever attached to square damper shaft. Adjustable stops, directional control valve, related plumbing.

- ⊗ Bulky
- ⊗ Complex mounting
- ⊗ Hard to service, adjust

!

Streamlined, safer, built-in rotation adjustments, simple mounting.

- ✓ Reduced costs
- ✓ Improved safety
- ✓ Simplified production

## CONFIGURE & DOWNLOAD CAD FILES - <https://rotomation.com/cad/>

Rotomation Rotary Actuators have billions of standard configurations. To better assist our customers, we developed RotoCAD, our online CAD configuration tool. Use RotoCAD to easily configure the correct product to meet your application needs.

### Why use RotoCAD?

- Accurate and concise, configured to order rotary actuators.
- Quick turnaround.
- See what options benefit you and inspect every detail in real-time.
- Instant Updates – preview the exact product you’ve customized.
- Downloadable 2D or 3D models in 30 different file formats.

Our Engineers are available to consult with and welcome your questions, call our office at (386) 676-6377.

#### A032 Rotary Actu...

Need Guidance? Click the information icons next to each feature.

Please use the information icons for help.

Shaft Keyway Orientation

Bumpers

Preloaded Keyway

Adjustable Rotation

Magnetic Control

Seals

Port Position

Mount Plates

Multi-position actuators (except A032), Steppers, and specials are not available through RotoCAD. Contact our office and we will get you the model you need within a day.

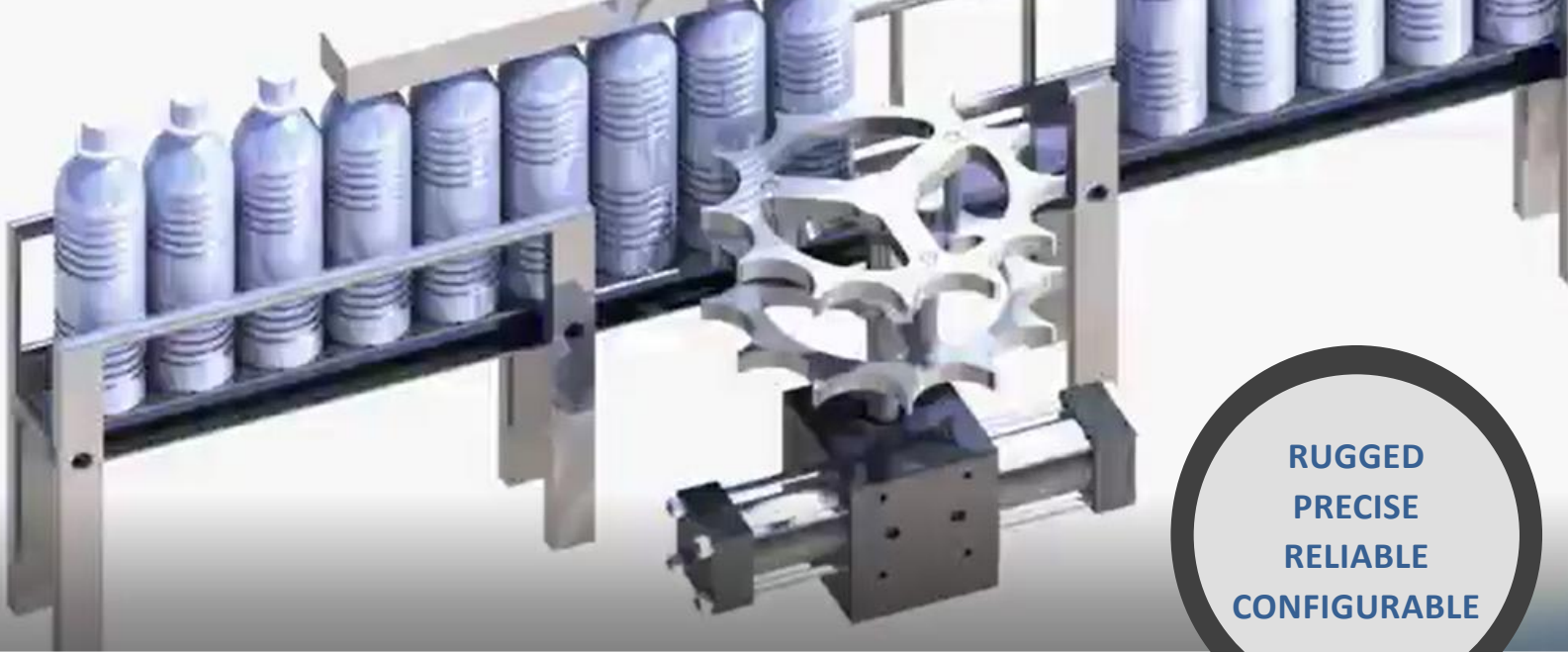

**RUGGED  
PRECISE  
RELIABLE  
CONFIGURABLE**

# PICK YOUR MOTION

Then Customize The Actuator That Fits Your Application

## Rotary Actuators

Basic rotary actuators provide back and forth rotation between two positions.



## Multi-Position Rotary Actuators

Multi-position rotary actuators provide back and forth rotation between three, four, or five positions in any sequence.



## Indexing Actuators

Indexing Actuators provide unidirectional rotation in fixed precise steps to hard stops within + or - 0.2 degrees. These actuators also prevent backward rotation and feature no accumulating error.

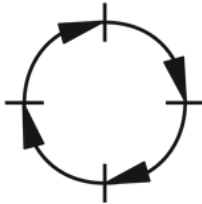

## Stepping Actuators

Stepping actuators provide unidirectional rotation in steps, like indexing actuators, but without the hard stops.

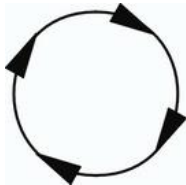

## Multi-Motion Actuators

Multi-motion actuators combine a rotary section with a linear cylinder to provide independently-controlled linear and rotary motion. Choose between two position, multi-position, or indexing rotary motion.

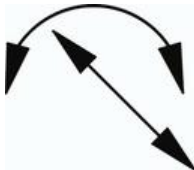

# Rotary Actuator Applications

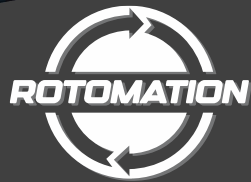

Watch videos on our youtube channel



## Rotary Actuators

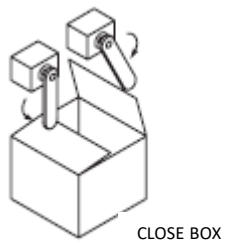
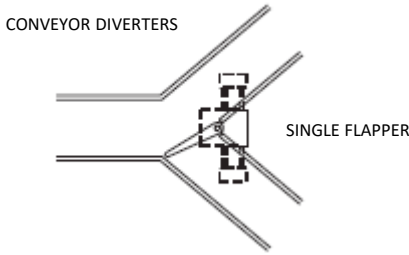

## Multi-Position Actuators

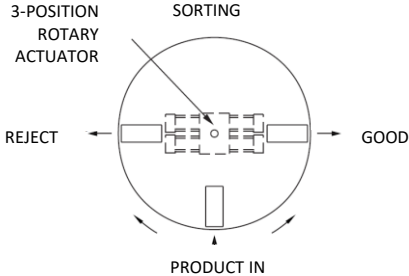
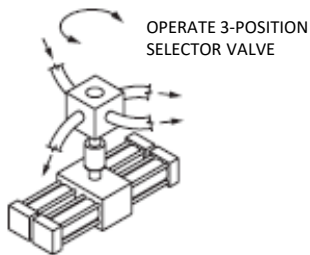

## Indexing Actuators

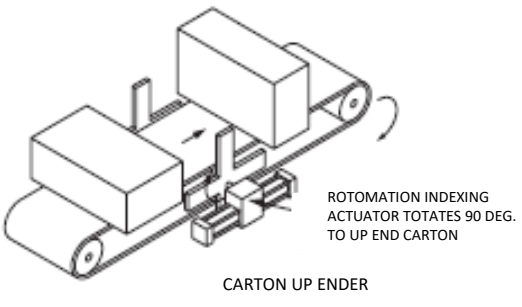
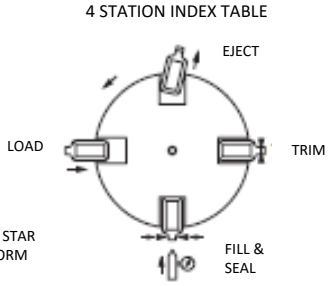
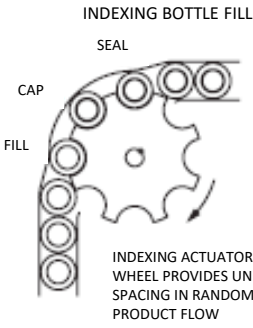

## Stepping Actuators

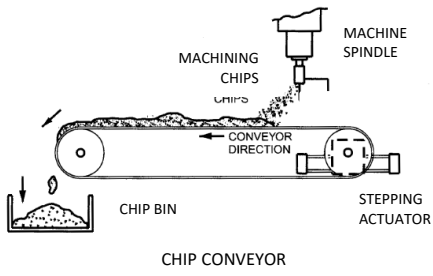
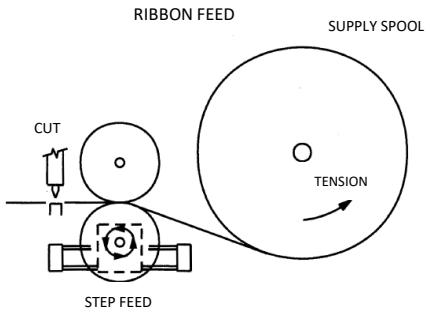
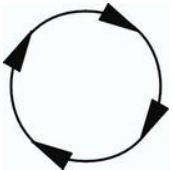

## Multi-Motion Actuators

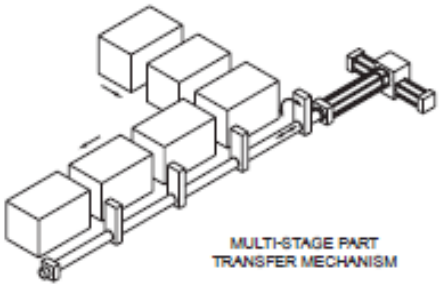
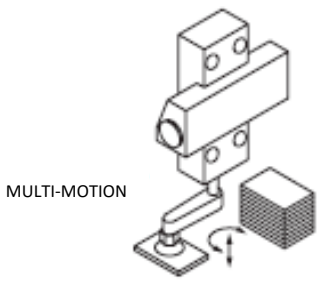
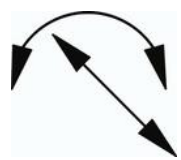

## CUSTOM ACTUATORS

Rotomation welcomes requests for special actuators because we understand how they can save our customers money by reducing the cost of extra parts or engineering time and/or improving their product or process. About 40% of the actuators we produce have some non-standard feature to better adapt to the customer's load or working conditions.

For more specialized applications or actuators that do not conform to the same principles of our standard product line, our expert team of design engineers will work with you to establish specifications tailored to meet your specific requirements, then they will design, develop and test a new product from the ground up if required. Whether you need one unit or thousands, we will produce what you need quickly and at a reasonable price.

We assign a special code in the part number of every special actuator that points to a unique bill of material that contains all the specifications and modifications necessary to reproduce a specific special actuator to simplify reordering. Upon request, we can also declare a special actuator to be proprietary to the OEM or distributor who ordered it originally to protect their investment.

### CUSTOM-MADE ACTUATORS

If your application requires an actuator completely different from the products we offer, in form or function, we can create a solution for your application.

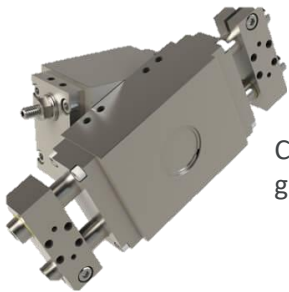

Custom-made rotating gripper.

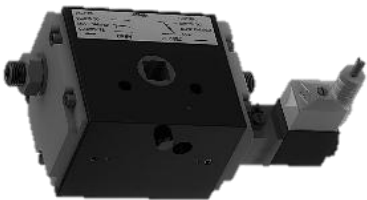

Custom-made damper actuator.

### CUSTOMIZED ACTUATORS

If your application requires a simple modification to one or more parts on one of our standard units or you need us to make one of our standard actuators in some other material due to special environmental requirements, we'll be glad to help you. See a few examples of recent customizations made for some of our customers below.



Customized extra compact rotary actuator, based on our standard A752.

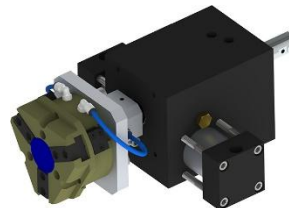

Special X3 indexing actuator with integrated dual channel air manifold to provide air to a gripper installed on a custom Shaft Mounting Adapter.

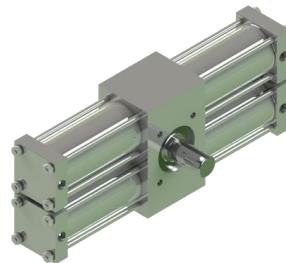

Special 316 stainless steel A42 rotary actuator.

# TIE ROD ROTARY ACTUATORS SINGLE & DUAL RACKS



Single rack actuators are designed for general applications where reliability and durability are important and where a small amount of lash (free rotary play of the shaft) is tolerable. Fifteen standard rotations, from 30 to 730°, and special rotations available up to 1,080°.

Dual rack actuators have the additional advantages of double torque and zero lash at the ends of the rotation without increasing the footprint of the actuator.

|   | STANDARD ROTATIONS (degrees) | SHAFT SIZES (dia.)   | TORQUE (at 80 psi) | BALL BEARING RATINGS (lbs.) | PORT SIZE        | AVAILABLE OPTIONS                          |
|---|------------------------------|--|--------------------|-----------------------------|------------------|--|
| <b>A01</b>    | 15 angles, from 30 to 730    | Standard: .250"<br>Options: .187" & D .250"                                | 6 in-lbs.          | Radial: 77<br>Axial: 19     | 10-32 or 1/8 NPT | A, C, D, F, MP, MS, Q, T, V, VT            |
| <b>A1</b>     | 15 angles, from 30 to 730    | Standard: .375"<br>Options: .250", D .375", & HS .375" I.D.                | 12 in-lbs.         | Radial: 305<br>Axial: 76    | 10-32 or 1/8 NPT | A, C, D, F, HS, MP, MS, Q, T, V, VT        |
| <b>A12</b>   | 15 angles, from 30 to 730    | Standard: .375"<br>Options: .250", D .375", & HS .375" I.D.                | 24 in-lbs.         | Radial: 305<br>Axial: 76    | 10-32 or 1/8 NPT | A, C, D, F, HS, MP, MS, Q, T, V, VT        |
| <b>A2</b>   | 15 angles, from 30 to 730    | Standard: .500"<br>Options: D .500" & HS .375" I.D.                        | 39 in-lbs.         | Radial: 1,030<br>Axial: 257 | 1/8 NPT          | A, C, D, F, HD, HS, J, MP, MS, Q, T, V, VT |
| <b>A22</b>  | 15 angles, from 30 to 730    | Standard: .500"<br>Options: D .500" & HS .375" I.D.                        | 78 in-lbs.         | Radial: 1,030<br>Axial: 257 | 1/8 NPT          | A, C, D, F, J, HD, HS, MP, MS, Q, T, V, VT |
| <b>A3</b>   | 15 angles, from 30 to 730    | Standard: .750"<br>Options: D .750", HS .750"                              | 119 in-lbs.        | Radial: 2,020<br>Axial: 500 | 1/4 NPT          | A, C, D, F, HD, HS, J, MP, MS, Q, T, V, VT |
| <b>A32</b>  | 15 angles, from 30 to 730    | Standard: .750"<br>Options: D .750", HS .750", & HS .625" I.D.             | 238 in-lbs.        | Radial: 2,020<br>Axial: 500 | 1/4 NPT          | A, C, D, F, J, HD, HS, MP, MS, Q, T, V, VT |
| <b>A4</b>   | 15 angles, from 30 to 730    | Standard: 1.000" or 1.125"<br>Options: D 1.000", D 1.125", & HS .750" I.D. | 277 in-lbs.        | Radial: 2,020<br>Axial: 500 | 1/4 NPT          | A, C, D, F, HD, HS, J, MP, MS, Q, T, V, VT |
| <b>A42</b>  | 15 angles, from 30 to 730    | Standard: 1" or 1.125"<br>Options: D 1", D 1.125", & HS .750" I.D.         | 554 in-lbs.        | Radial: 2,020<br>Axial: 500 | 1/4 NPT          | A, C, D, F, J, HD, HS, MP, MS, Q, T, V, VT |

### TABLE LEGEND:

**A:** Adjustable Rotation  
**C:** Cushions  
**D:** Double Ended Shafts  
**F:** Flow Controls

**HD:** Heavy Duty (A or K)  
**HS:** Hollow Shaft  
**J:** Washdown Protection  
**MP:** Mount Plates  
**MS:** Magnetic Switches

**Q:** Bumpers  
**T:** Hydraulic Service Seals  
**V:** Fluorocarbon Seals  
**VT:** Fluorocarbon Hydraulic Service Seals



386-676-6377



rotomation.com







sales@rotomation.com

# THREE-POSITION TIE ROD ROTARY ACTUATORS DUAL RACKS

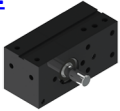

Rotomation's 3-position actuators provide an additional intermediate position, also known as reference position (RP) using internal stops. They share the same footprint of our standard dual rack rotary (2-position) actuators but provide the output torque equivalent to our single rack rotary actuators.

|  | TOTAL ROTATION (degrees) | SHAFT SIZES (dia.)   | TORQUE (at 80 psi) | BALL BEARING RATINGS (lbs.) | PORT SIZE        | AVAILABLE OPTIONS                          |
|--|--------------------------|--|--------------------|-----------------------------|------------------|--|
| <a href="#">A032</a><br>  | From 30 to 190 total     | Standard: .375"<br>Options: .25", & 8mm                                    | 0.057 in-lbs.      | Radial: 300<br>Axial: 76    | 10-32, M5        | A, D, MP, MS, Q, V                         |
| <a href="#">A12</a><br>   | From 30 to 730 total     | Standard: .375"<br>Options: .250", D .375", & HS .375" I.D.                | 12 in-lbs.         | Radial: 305<br>Axial: 76    | 10-32 or 1/8 NPT | A, C, D, F, HS, MP, MS, Q, T, V, VT        |
| <a href="#">A22</a><br>  | From 30 to 730 total     | Standard: .500"<br>Options: D .500" & HS .375" I.D.                        | 39 in-lbs.         | Radial: 1,030<br>Axial: 257 | 1/8 NPT          | A, C, D, F, HD, HS, J, MP, MS, Q, T, V, VT |
| <a href="#">A32</a><br> | From 30 to 730 total     | Standard: .750"<br>Options: D .750", HS .750", & HS .625" I.D.             | 119 in-lbs.        | Radial: 2,020<br>Axial: 500 | 1/4 NPT          | A, C, D, F, HD, HS, J, MP, MS, Q, T, V, VT |
| <a href="#">A42</a><br> | From 30 to 730 total     | Standard: 1.000" or 1.125"<br>Options: D 1.000", D 1.125", & HS .750" I.D. | 277 in-lbs.        | Radial: 2,020<br>Axial: 500 | 1/4 NPT          | A, C, D, F, HD, HS, J, MP, MS, Q, T, V, VT |

#### TABLE LEGEND:

**A:** Adjustable Rotation  
**C:** Cushions  
**D:** Double Ended Shafts  
**F:** Flow Controls

**HD:** Heavy Duty (A or K)  
**HS:** Hollow Shaft  
**J:** Washdown Protection  
**MP:** Mount Plates  
**MS:** Magnetic Switches

**Q:** Bumpers  
**T:** Hydraulic Service Seals  
**V:** Fluorocarbon Seals  
**VT:** Fluorocarbon Hydraulic Service Seals



# DESIGN YOUR 5/8 BORE

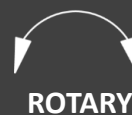

## CONFIGURATOR LINK

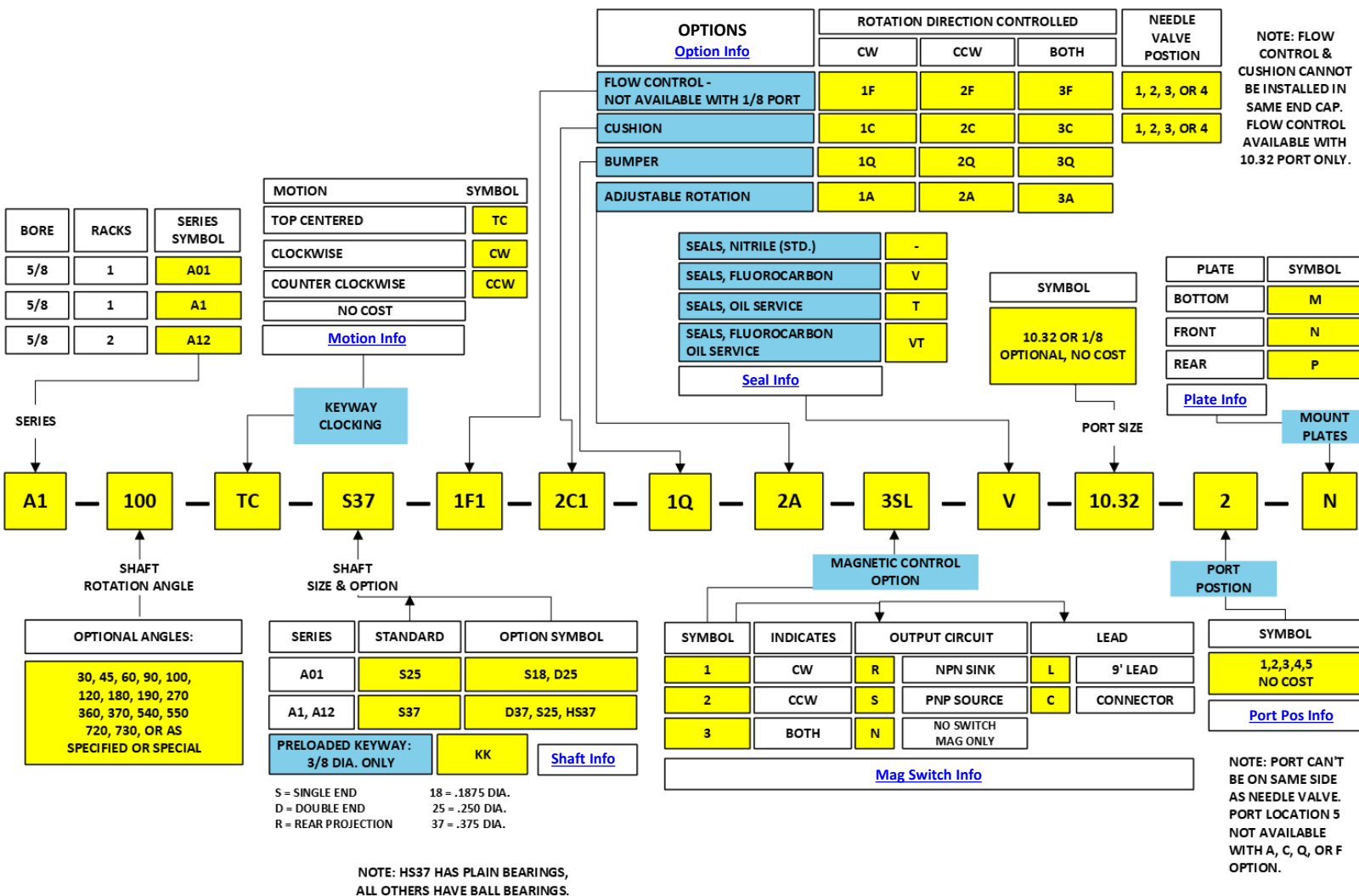

When an option is not required, leave the box blank.

Rotomation can provide units to almost any configuration. Contact our office for special requirements.

To expedite the order of a duplicate of a prior unit, you can reference the serial or stock number. If the number cannot be read from the label, peel it off and find the number stamped into the body.

Extension cables for magnetic switches with the connector option are available and must be ordered separately ([mag switch info](#)). Switches can be purchased and installed in the field for actuators ordered with the switch only (3N option).

### SEAL REPAIR KIT INFO

### CALCULATED TORQUE IN INCH-POUNDS

Deduct 10% for friction

| UNIT | TORQUE FACTOR | MAX PSI | MAX TORQUE | OPERATING PRESSURE IN PSI |     |     |    |     |     |
|------|---------------|---------|------------|---------------------------|-----|-----|----|-----|-----|
|      |               |         |            | 25                        | 50  | 60  | 80 | 100 | 200 |
| A01  | .077          | 250     | 19         | 1.9                       | 3.9 | 4.6 | 6  | 8   | 15  |
| A1   | .153          | 250     | 38         | 3.8                       | 7.7 | 9.2 | 12 | 15  | 31  |
| A12  | .306          | 250     | 77         | 7.7                       | 15  | 18  | 24 | 31  | 61  |



386-676-6377



rotomation.com



sales@rotomation.com

# DESIGN YOUR 1"-2" BORE

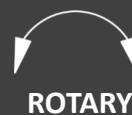

## CONFIGURATOR LINK

### Option Info

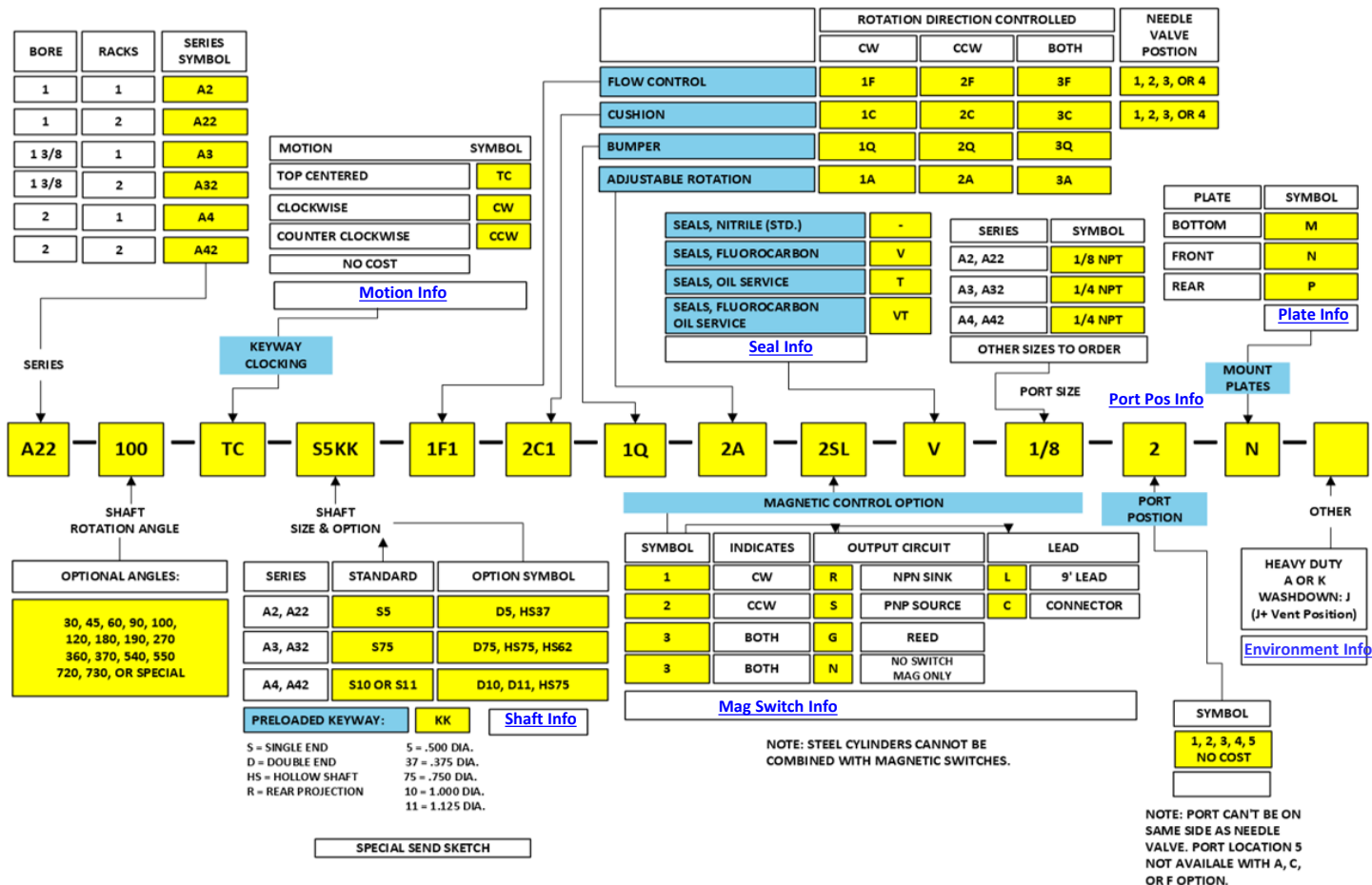

When an option is not required, leave the box blank.

Rotomation can provide units to almost any configuration. Contact our office for special requirements.

To expedite the order of a duplicate of a prior unit, you can reference the serial or stock number. If the number cannot be read from the label, peel it off and find the number stamped into the body.

Extension cables for magnetic switches with the connector option are available and must be ordered separately ([mag switch info](#)). Switches can be purchased and installed in the field for actuators ordered with the switch only (3N option).

### SEAL REPAIR KIT INFO

### CALCULATED TORQUE IN INCH-POUNDS

Deduct 10% for friction

| UNIT | TORQUE FACTOR | MAX PSI | MAX TORQUE | OPERATING PRESSURE IN PSI |     |     |     |     |      |
|------|---------------|---------|------------|---------------------------|-----|-----|-----|-----|------|
|      |               |         |            | 25                        | 50  | 60  | 80  | 100 | 200  |
| A2   | 0.49          | 250     | 123        | 12                        | 25  | 29  | 39  | 49  | 98   |
| A22  | 0.98          | 250     | 245        | 25                        | 49  | 78  | 78  | 98  | 196  |
| A3   | 1.49          | 250     | 373        | 37                        | 75  | 119 | 119 | 149 | 298  |
| A32  | 2.98          | 250     | 745        | 75                        | 149 | 238 | 238 | 298 | 596  |
| A4   | 3.46          | 250     | 865        | 87                        | 173 | 277 | 277 | 346 | 692  |
| A42  | 6.92          | 200     | 1384       | 173                       | 346 | 554 | 554 | 692 | 1384 |

High pressure option (HP) should be used for pressures exceeding 250 psi.



386-676-6377



rotomation.com



sales@rotomation.com

# DESIGN YOUR 1"-2" BORE MULTI-POSITION



[REQUEST A CAD](#)

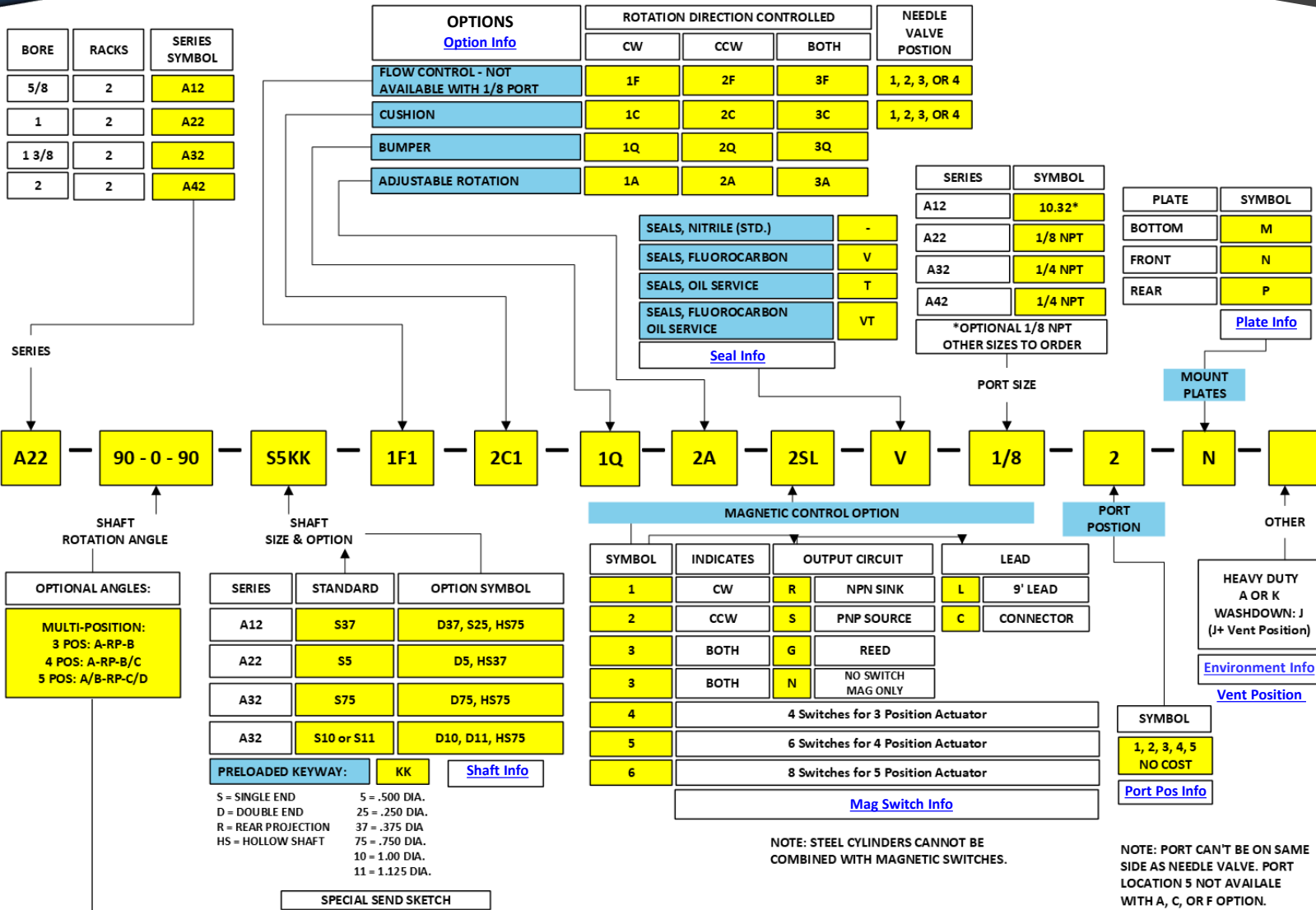

### 3-POSITION ACTUATOR

Uses internal stops for drive to any of three positions in any sequence. Use torque factor of A1, A2, A3, or A4. Three-position also available on A032, but different principle.

To specify the keyway positions desired in a 3-position dual rack actuator:

- 1) Determine central reference point RP at 0 to 360 deg. Clockwise from 12:00.
- 2) Determine angle CCW from RP: A.
- 3) Determine angle CW from RP: B.

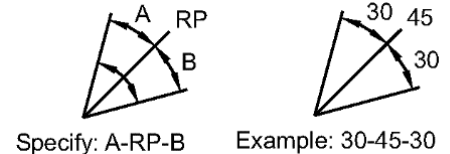

When an option is not required, leave the box blank.

Rotomation can provide units to almost any configuration. Contact our office for special requirements.

To expedite the order of a duplicate of a prior unit, you can reference the serial or stock number. If the number cannot be read from the label, peel it off and find the number stamped into the body.

Extension cables for magnetic switches with the connector option are available and must be ordered separately ([mag switch info](#)). Switches can be purchased and installed in the field for actuators ordered with the switch only (3N option).

[SEAL REPAIR KIT INFO](#)

### CALCULATED TORQUE IN INCH-POUNDS

Deduct 10% for friction

| UNIT | TORQUE FACTOR | MAX PSI | MAX TORQUE | OPERATING PRESSURE IN PSI |     |     |     |     |     |
|------|---------------|---------|------------|---------------------------|-----|-----|-----|-----|-----|
|      |               |         |            | 25                        | 50  | 60  | 80  | 100 | 200 |
| A12  | .153          | 250     | 38         | 3.8                       | 7.7 | 9.2 | 12  | 15  | 31  |
| A22  | 0.49          | 250     | 123        | 12                        | 25  | 29  | 39  | 49  | 98  |
| A32  | 1.49          | 250     | 373        | 37                        | 75  | 119 | 119 | 149 | 298 |
| A42  | 3.46          | 250     | 865        | 87                        | 173 | 277 | 277 | 346 | 692 |

High pressure option (HP) should be used for pressures exceeding 250 psi.



# 4 & 5-POSITION DUAL RACK TIE ROD

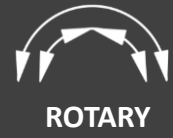

With internal stops and one or two sets of auxiliary cylinders used for the two or three intermediate positions, respectively, our four and five-position actuators are built to resemble their two-position counterparts, except for the external auxiliary cylinders that add to the overall length of the unit.

Available in all our tie rod actuator sizes, with the same lead time as our regular rotary actuators, these actuators offer extreme configurability and reliable, repeatable positioning at a cost much lower than a servo motor system but their positions are not programmable. Like our [three-position actuators](#), the output torque on these units is that of a single rack unit. They can rotate to any of its 4 or 5 positions in any sequence from any existing position by simply activating the proper directional control valve configuration.

**Features:**

- Rotate to any of the 4 or 5 positions in any direction and any sequence
- Extremely configurable to fit your specific needs
- Various rotation angles in almost any combination with flexible reference position
- Select from the same shaft options available in our regular rotary actuators
- Optional magnetic switches in various configurations
- Optional rotation adjusters, bumpers, cushions, flow controls<sup>1</sup>

<sup>1</sup>Only flow controls can affect all positions; other control options affect end positions only.

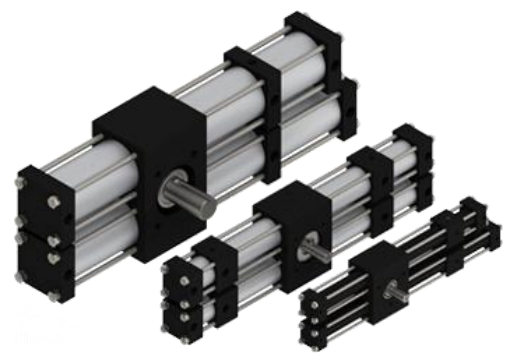

**KEYWAY CLOCKING FOR FOUR OR FIVE-POSITION ACTUATORS**

Pairs of auxiliary cylinders and pistons with stop rods added to three-position actuators provide additional intermediate keyway stop positions. All positions are accessible in any sequence. Note that intermediate end caps are vented; filters or mufflers should be installed on vents to exclude dust and other contaminants, or the vents plumbed to clean, dry area.

**FOUR-POSITION ACTUATOR**

To specify the keyway positions desired in a 4-position dual rack actuator with auxiliary cylinders:

- 1) Determine an inner reference position RP at 0 to 360 deg. Clockwise from 12:00.
- 2) Determine angle CCW from RP: A.
- 3) Determine angles CW from RP: B&C.
- 4) Enclose RP with dashes, separate others with slash.

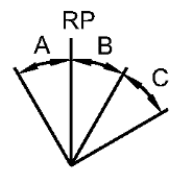

Specify: A-RP-B/C

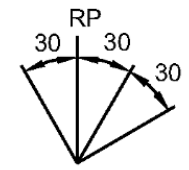

Example: 30-0-30/30

**FIVE-POSITION ACTUATOR**

To specify the keyway positions desired in a 5-position dual rack actuator with auxiliary cylinders:

- 1) Determine an inner reference position RP at 0 to 360 deg. Clockwise from 12:00.
- 2) Determine angles CCW from RP: A, B.
- 3) Determine angles CW from RP: C, D.
- 4) Enclose RP with dashes, separate others with slash.

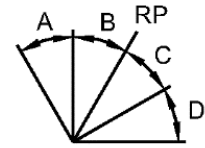

Specify: A/B-RP-C/D

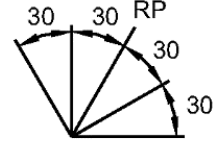

Example: 30/30-30-30/30



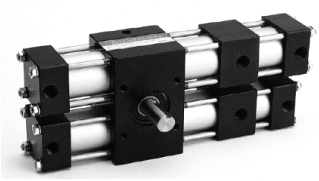

Shown: four-position A22-30-0-30/30-S5-1/8-4



**Contact our office for CAD and/or part number configurations.**

Rotomation's compact rotary actuators are designed for applications where high torque in a small space is important. Their unitized construction minimizes space requirements and provides a clean appearance. Specific characteristics and features of each series.

## 2 and 3 Position Compact Rotary Actuators

| STANDARD ROTATIONS (degrees)  | SHAFT SIZES (dia.)                       | TORQUE (at 80 psi)  | BALL BEARING RATINGS (lbs.)  | PORT SIZE                | AVAILABLE OPTIONS      |                           |
|---|--|---|--|--------------------------|------------------------|---------------------------|
| <a href="#">A032 2-Position</a><br>   | 30,45,60, 90, 100, 120, 180, 190         | Standard: .375" & R .375" dia.<br>Options: D .375", .250", R .250", 8mm, R 8mm, & D 8mm | 9 in-lbs.  | Radial: 305<br>Axial: 76 | 10-32                  | A, MP, MS, Q, V           |
| <a href="#">A032 3-Position</a><br> | 45-0-45<br>50-0-50<br>90-0-90<br>95-0-95 | Standard: .375" & R .375<br>Options: D .375", .250", R .250", 8mm, R 8mm, & D 8mm       | Toward End Positions: 9 in-lbs.<br>Toward Center Position: 4.5 in-lbs. | Radial: 305<br>Axial: 76 | 10-32                  | A, MP, MS, Q, V           |
| <a href="#">AL75</a><br>            | 50, 95                                   | Standard: .250", D.250", R .250"<br>Options: None                                       | Varies 7-11 in-lbs.  | Radial: 77<br>Axial: 19  | 10-32                  | A, J, MS, Q               |
| <a href="#">A752</a><br>            | 30, 45, 60, 90, 100, 120, 180, 190       | Standard: .375"<br>Options: HS .375" I.D. & D .375"                                     | 35 in-lbs.   | Radial: 305<br>Axial: 76 | 10-32<br>or<br>1/8 NPT | A, C, HS, MS, Q, T, V, VT |

### TABLE LEGEND:

**A:** Adjustable Rotation  
**C:** Cushions  
**D:** Double Ended Shafts  
**F:** Flow Controls

**HD:** Heavy Duty (A or K)  
**HS:** Hollow Shaft  
**J:** Washdown Protection  
**MP:** Mount Plates  
**MS:** Magnetic Switches

**Q:** Bumpers  
**R:** Rear Projection Shaft  
**T:** Hydraulic Service Seals  
**V:** Fluorocarbon Seals  
**VT:** Fluorocarbon Hydraulic Service Seals

# DESIGN YOUR A032

## 2-POSITION



### CONFIGURATOR LINK

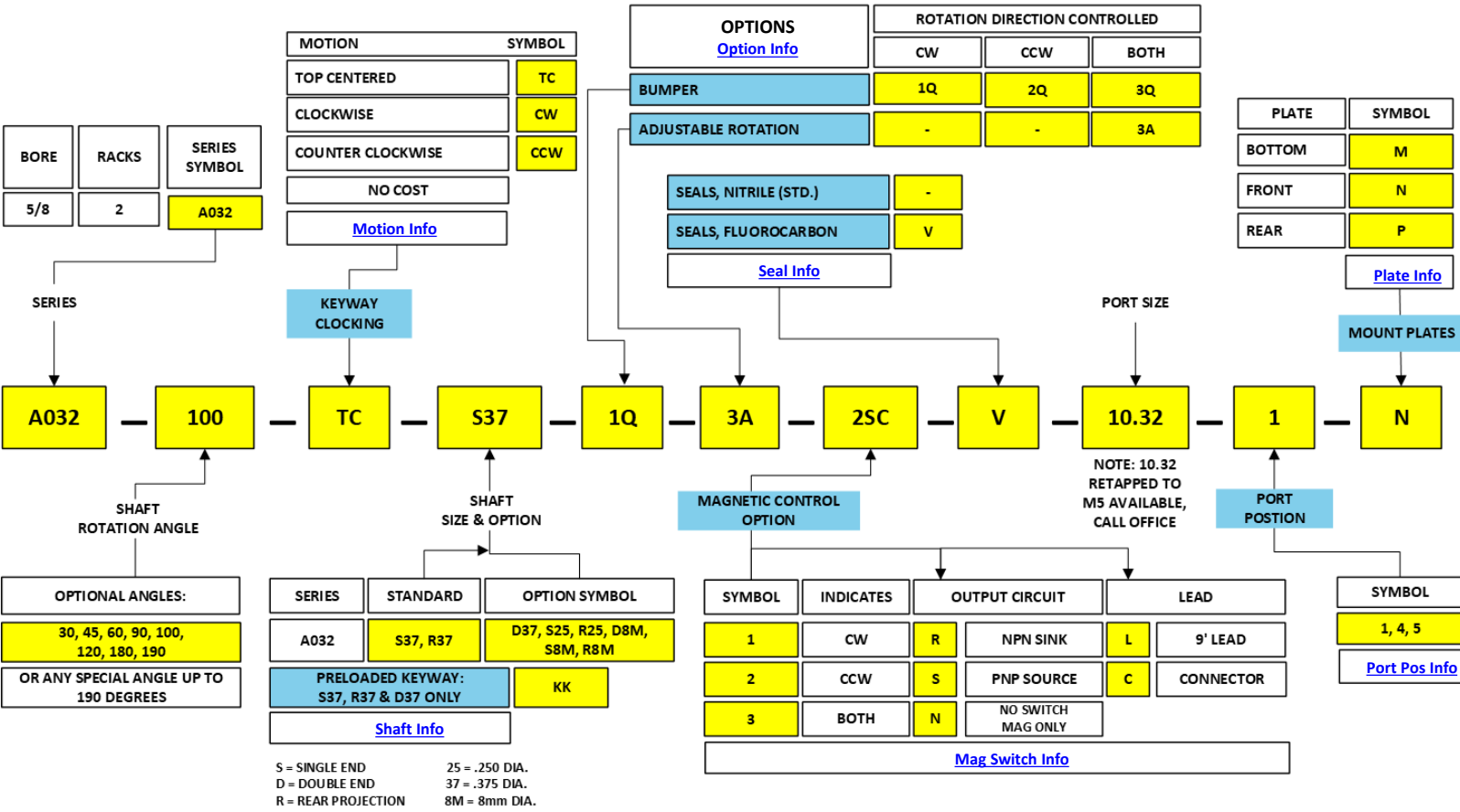

When an option is not required, leave the box blank.

Rotomation can provide units to almost any configuration. Contact our office for special requirements.

To expedite the order of a duplicate of a prior unit, you can reference the serial or stock number. If the number cannot be read from the label, peel it off and find the number stamped into the body.

Extension cables for magnetic switches with the connector option are available and must be ordered separately ([mag switch info](#)). Switches can be purchased and installed in the field for actuators ordered with the switch only (3N option).

### CALCULATED TORQUE IN INCH-POUNDS

Deduct 10% for friction

### SEAL REPAIR KIT INFO

|               |         | OPERATING PRESSURE IN PSI |     |     |     |    |     |     |  |
|---------------|---------|---------------------------|-----|-----|-----|----|-----|-----|--|
| TORQUE FACTOR | MAX PSI | MAX TORQUE                | 25  | 50  | 60  | 80 | 100 | 200 |  |
| 0.115         | 150     | 17                        | 2.9 | 5.8 | 6.9 | 9  | 12  | -   |  |



386-676-6377



rotomation.com



sales@rotomation.com

# DESIGN YOUR A032

## 3-POSITION



### CONFIGURATOR LINK

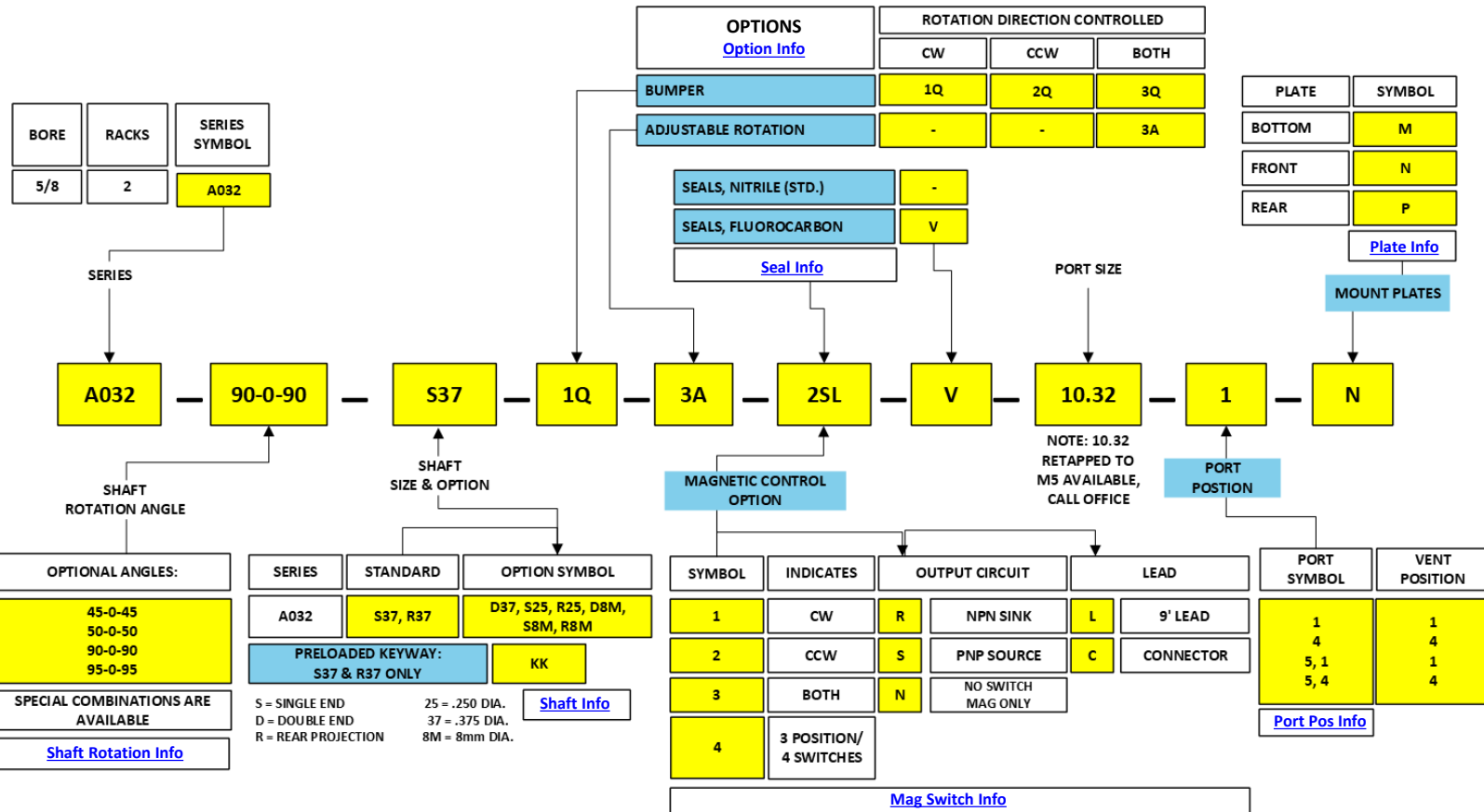

When an option is not required, leave the box blank.

Rotomation can provide units to almost any configuration. Contact our office for special requirements.

To expedite the order of a duplicate of a prior unit, you can reference the serial or stock number. If the number cannot be read from the label, peel it off and find the number stamped into the body.

Extension cables for magnetic switches with the connector option are available and must be ordered separately ([mag switch info](#)). Switches can be purchased and installed in the field for actuators ordered with the switch only (3N option).

### SEAL REPAIR KIT INFO

### CALCULATED TORQUE IN INCH-POUNDS

Deduct 10% for friction

|                          |      | OPERATING PRESSURE IN PSI |         |            |     |     |     |     |     |
|--------------------------|------|---------------------------|---------|------------|-----|-----|-----|-----|-----|
|                          |      | TORQUE FACTOR             | MAX PSI | MAX TORQUE | 25  | 50  | 60  | 80  | 100 |
| GOING TO END POSITION    | .115 | 130                       | 15      | 2.9        | 5.8 | 6.9 | 9.2 | 12  |     |
| GOING TO CENTER POSITION | .057 | 130                       | 17      | 1.4        | 2.9 | 3.4 | 4.6 | 5.7 |     |



386-676-6377



rotomation.com



sales@rotomation.com

## CONFIGURATOR LINK

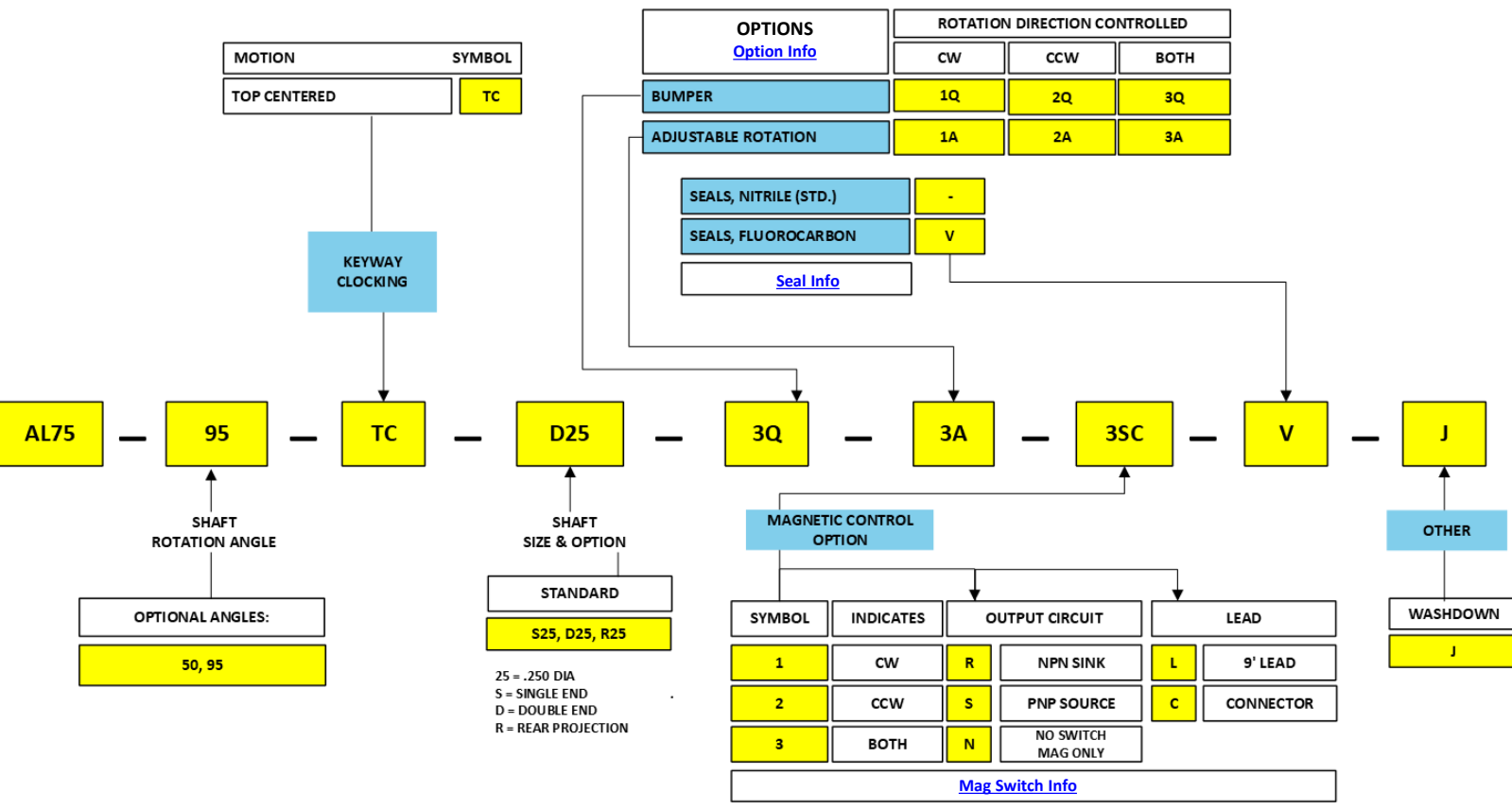

When an option is not required, leave the box blank.

Rotomation can provide units to almost any configuration. Contact our office for special requirements.

To expedite the order of a duplicate of a prior unit, you can reference the serial or stock number. If the number cannot be read from the label, peel it off and find the number stamped into the body.

Extension cables for magnetic switches with the connector option are available and must be ordered separately ([mag switch info](#)). Switches can be purchased and installed in the field for actuators ordered with the switch only (3N option).

### SEAL REPAIR KIT INFO

### CALCULATED TORQUE IN INCH-POUNDS

Deduct 10% for friction

| OPERATING PRESSURE IN PSI |     |      |      |
|---------------------------|-----|------|------|
| DEGREE FROM CENTER        | 60  | 80   | 100  |
| 0                         | 8.3 | 11.0 | 13.8 |
| 5                         | 8.2 | 11.2 | 13.7 |
| 10                        | 8.1 | 10.8 | 13.6 |
| 15                        | 8.0 | 10.6 | 13.3 |
| 20                        | 7.8 | 10.4 | 12.9 |
| 22.5                      | 7.6 | 10.2 | 12.7 |
| 25                        | 7.5 | 10.0 | 12.5 |
| 30                        | 7.1 | 9.5  | 11.9 |
| 35                        | 6.8 | 9.0  | 11.3 |
| 40                        | 6.3 | 8.4  | 10.5 |
| 45                        | 5.8 | 7.8  | 9.7  |
| 50                        | 5.5 | 7.1  | 8.8  |





## CONFIGURATOR LINK

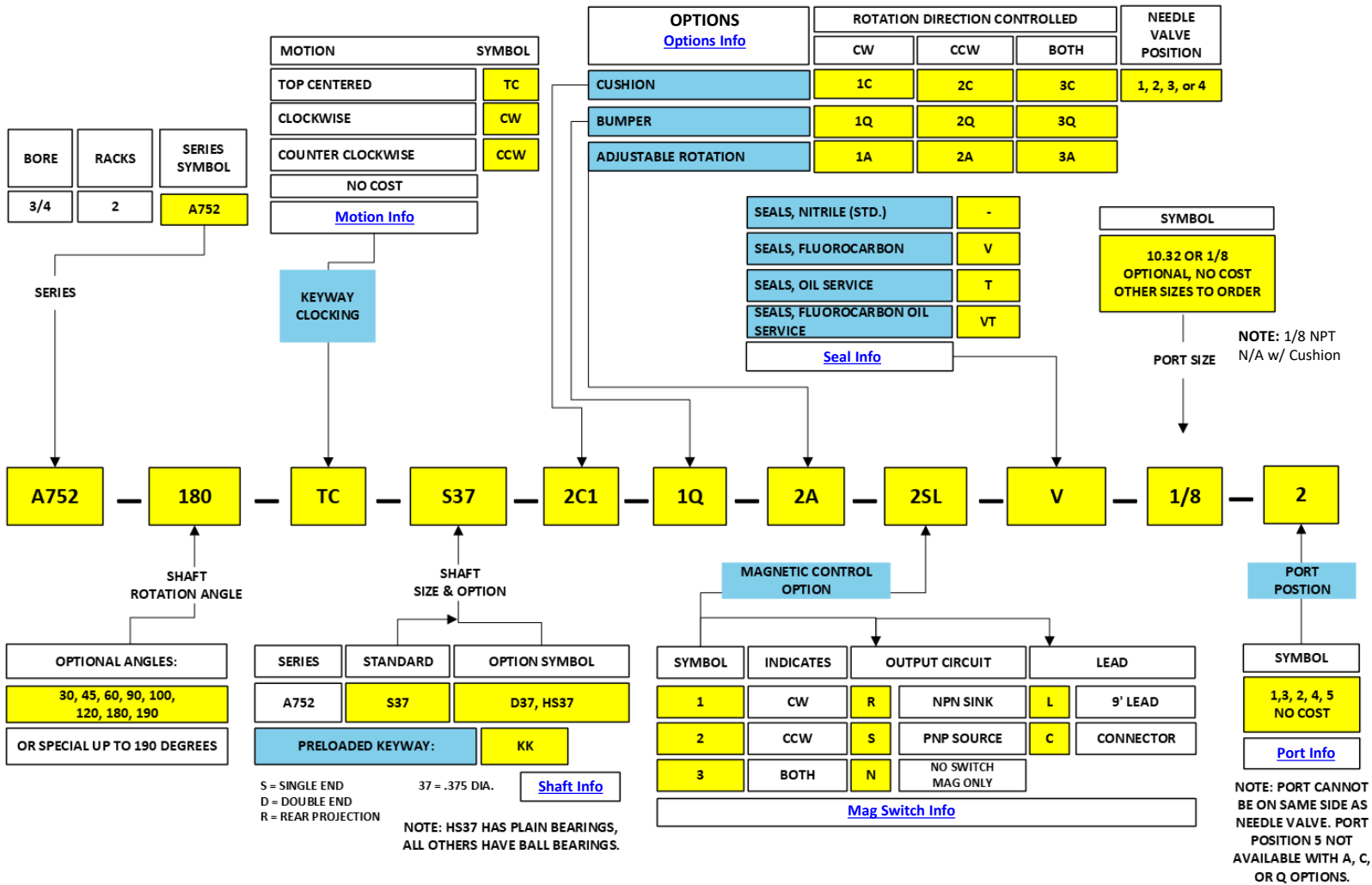

When an option is not required, leave the box blank.

Rotomation can provide units to almost any configuration. Contact our office for special requirements.

To expedite the order of a duplicate of a prior unit, you can reference the serial or stock number. If the number cannot be read from the label, peel it off and find the number stamped into the body.

Extension cables for magnetic switches with the connector option are available and must be ordered separately ([mag switch info](#)). Switches can be purchased and installed in the field for actuators ordered with the switch only (3N option).

### SEAL REPAIR KIT INFO

### CALCULATED TORQUE IN INCH-POUNDS

Deduct 10% for friction

| TORQUE FACTOR | MAX PSI | MAX TORQUE | OPERATING PRESSURE IN PSI |    |    |    |     |     |
|---------------|---------|------------|---------------------------|----|----|----|-----|-----|
|               |         |            | 25                        | 50 | 60 | 80 | 100 | 200 |
| 0.44          | 250     | 110        | 11                        | 22 | 26 | 35 | 44  | 88  |



# INDEXING ACTUATORS UNIT CUTAWAY

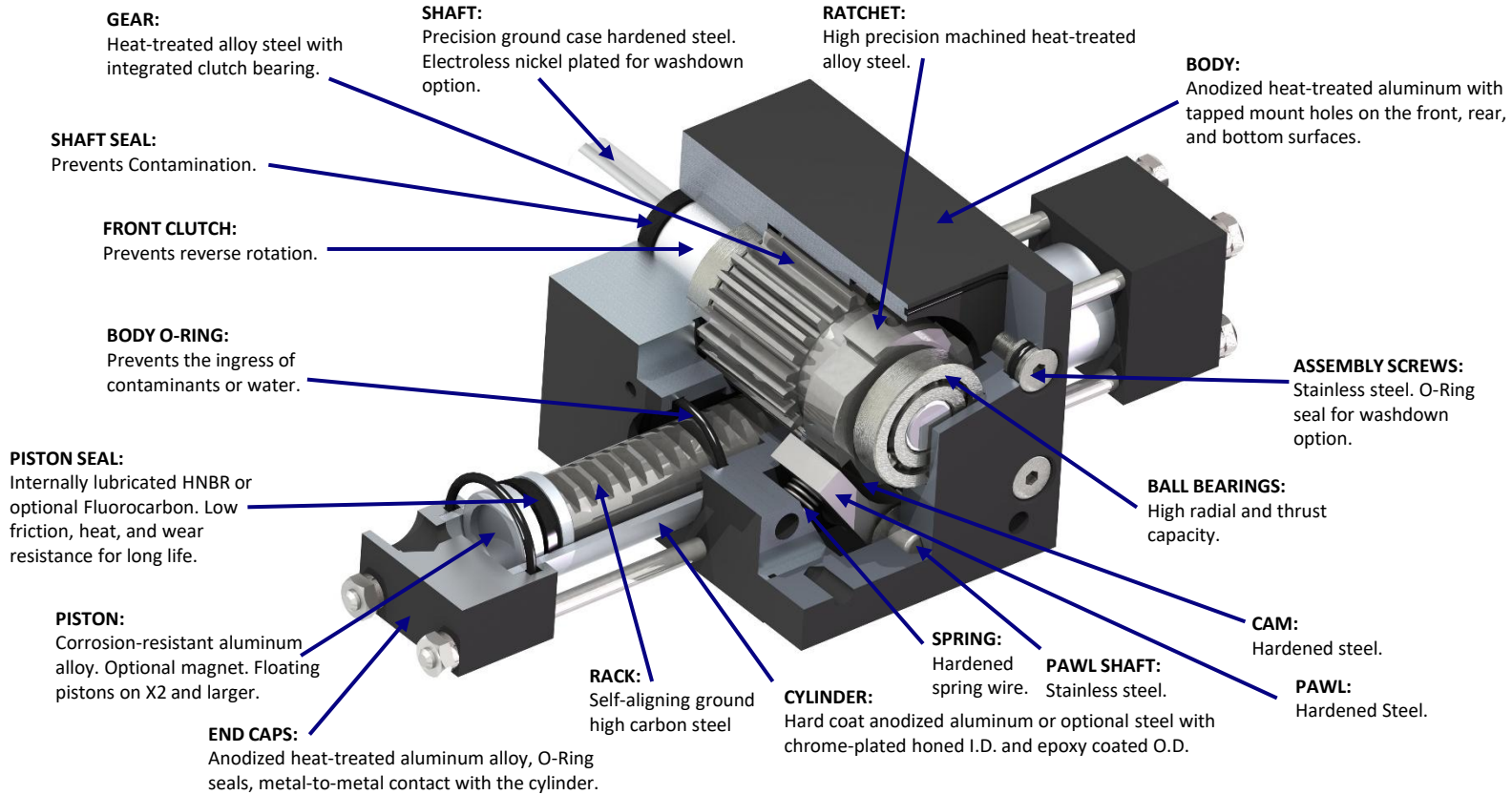

## USING ROTOMATION'S INDEXING ACTUATOR

The Rotomation indexer is a unique product that will provide reliable, fast, and accurate indexing motion from a compact package that is easily adapted to many applications. Understanding its operation and limitations will ensure success.

The indexer drives its shaft through accurate angular steps determined by its ratchet. Unit size and torque are similar to those of conventional rack and pinion actuators, and it is usually driven using a four-way valve and flow controls. When the drive cylinder is pressurized, the shaft rotates through its specified angle to a firm stop against the ratchet and is held there by air pressure. The cylinder is made long enough to prevent the rack from reaching the end of the stroke. The actuator is usually kept in this locked condition, holding its load in a registered position while processing of the workpiece takes place.

Then the control valve is reversed, pressurizing the reset cylinder. This causes the rack and pinion to move in the opposite (reset) direction, unlocking the shaft. In this condition, the shaft can free-wheel in the forward direction. In most applications, the drive stroke should immediately follow the completion of the reset stroke.

If the shaft is moved forward by external force or bounce, the stopping position of the shaft will not be affected unless it moves to near the next stop. In that case, the next drive stroke will skip that stop and drive the load partially to the next, often reaching it by inertia. The following cycles will be normal.

Because the pistons drive the shaft through a one-way clutch, cushions or shock absorbers cannot directly decelerate the load. Loads with some friction often will operate more smoothly and at higher speeds than purely inertial loads. If there is friction sufficient to stop the load within 20 degrees or so, then cushions can be effective by simply reducing the torque of the actuator near the end of the stroke, allowing the friction to slow the load.

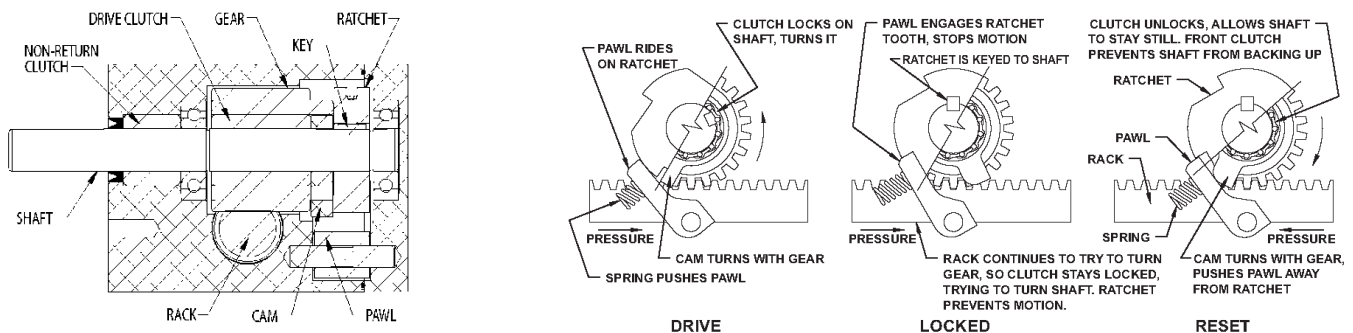

386-676-6377



rotomation.com



sales@rotomation.com

# INDEXING ROTARY ACTUATORS SINGLE & DUAL RACKS



Indexing Actuators provide unidirectional rotation in fixed precise steps to hard stops. These actuators also prevent backward rotation and feature no accumulating error. Proper sizing of an indexing actuator depends on the moment of inertia of the load about the center of rotation as well as any torque loads such as friction, gravity, bending, etc. Applications with a horizontal shaft must be considered very carefully because the indexer cannot resist forward torque such as that created gravity acting on an unbalanced load. Dual rack actuators produce twice as much torque for a given pressure compared to the single rack indexer of the same bore size. Contact our office with questions.

|   | STANDARD ROTATIONS (degrees)                 | SHAFT SIZES (dia.)                    | TORQUE (at 80 psi) or as Specified | BALL BEARING RATINGS (lbs.) | PORT SIZE        | AVAILABLE OPTIONS                |
|---|--|---------------------------------------|------------------------------------|-----------------------------|------------------|----------------------------------|
| <a href="#">X1</a>      | From 12 (30 steps/rev.) to 360 (1 step/rev.) | Standard: .375"<br>Options: D .375"   | 12 in-lbs.                         | Radial: 305<br>Axial: 76    | 10-32 or 1/8 NPT | C, F, J, MP, MS, Q, T, V, VT     |
| <a href="#">X12</a>    | From 12 (30 steps/rev.) to 360 (1 step/rev.) | Standard: .375"<br>Options: D .375"   | 24 in-lbs.                         | Radial: 305<br>Axial: 76    | 10-32 or 1/8 NPT | C, F, J, MP, MS, Q, T, V, VT     |
| <a href="#">X2</a>    | From 12 (30 steps/rev.) to 360 (1 step/rev.) | Standard: .500"<br>Options: D .500"   | 39 in-lbs.                         | Radial: 1,030<br>Axial: 257 | 1/8 NPT          | C, F, HD, MP, MS, Q, T, V, VT    |
| <a href="#">X22</a>  | From 12 (30 steps/rev.) to 360 (1 step/rev.) | Standard: .500"<br>Options: D .500"   | <b>75 psi MAX</b><br>= 73 in-lbs.  | Radial: 1,030<br>Axial: 257 | 1/8 NPT          | C, F, HD, MP, MS, Q, T, V, VT    |
| <a href="#">X3</a>    | From 12 (30 steps/rev.) to 360 (1 step/rev.) | Standard: .750"<br>Options: D .750"   | 119 in-lbs.                        | Radial: 1,030<br>Axial: 257 | 1/4 NPT          | C, F, HD, J, MP, MS, Q, T, V, VT |
| <a href="#">X32</a>   | From 12 (30 steps/rev.) to 360 (1 step/rev.) | Standard: .750"<br>Options: D .750"   | <b>60 psi MAX</b><br>= 179 in-lbs. | Radial: 1,030<br>Axial: 257 | 1/4 NPT          | C, F, HD, J, MP, MS, Q, T, V, VT |
| <a href="#">X4</a>   | From 12 (30 steps/rev.) to 360 (1 step/rev.) | Standard: 1.000"<br>Options: D 1.000" | 238 in-lbs.                        | Radial: 1,160<br>Axial: 290 | 1/4 NPT          | C, F, HD, J, MP, MS, Q, T, V, VT |
| <a href="#">X42</a>  | From 12 (30 steps/rev.) to 360 (1 step/rev.) | Standard: 1.000"<br>Options: D 1.000" | <b>60 psi MAX</b><br>= 415 in-lbs. | Radial: 1,160<br>Axial: 290 | 1/4 NPT          | C, F, HD, J, MP, MS, Q, T, V, VT |

### OPTIONS LEGEND:

**A:** Adjustable Rotation  
**C:** Cushions  
**D:** Double Ended Shafts  
**F:** Flow Controls

**HD:** Heavy Duty (A or K)  
**HS:** Hollow Shaft  
**J:** Washdown Protection  
**MP:** Mount Plates  
**MS:** Magnetic Switches

**Q:** Bumpers  
**T:** Hydraulic Service Seals  
**V:** Fluorocarbon Seals  
**VT:** Fluorocarbon Hydraulic Service Seals



386-676-6377



rotomation.com



sales@rotomation.com



### CONFIGURATOR LINK

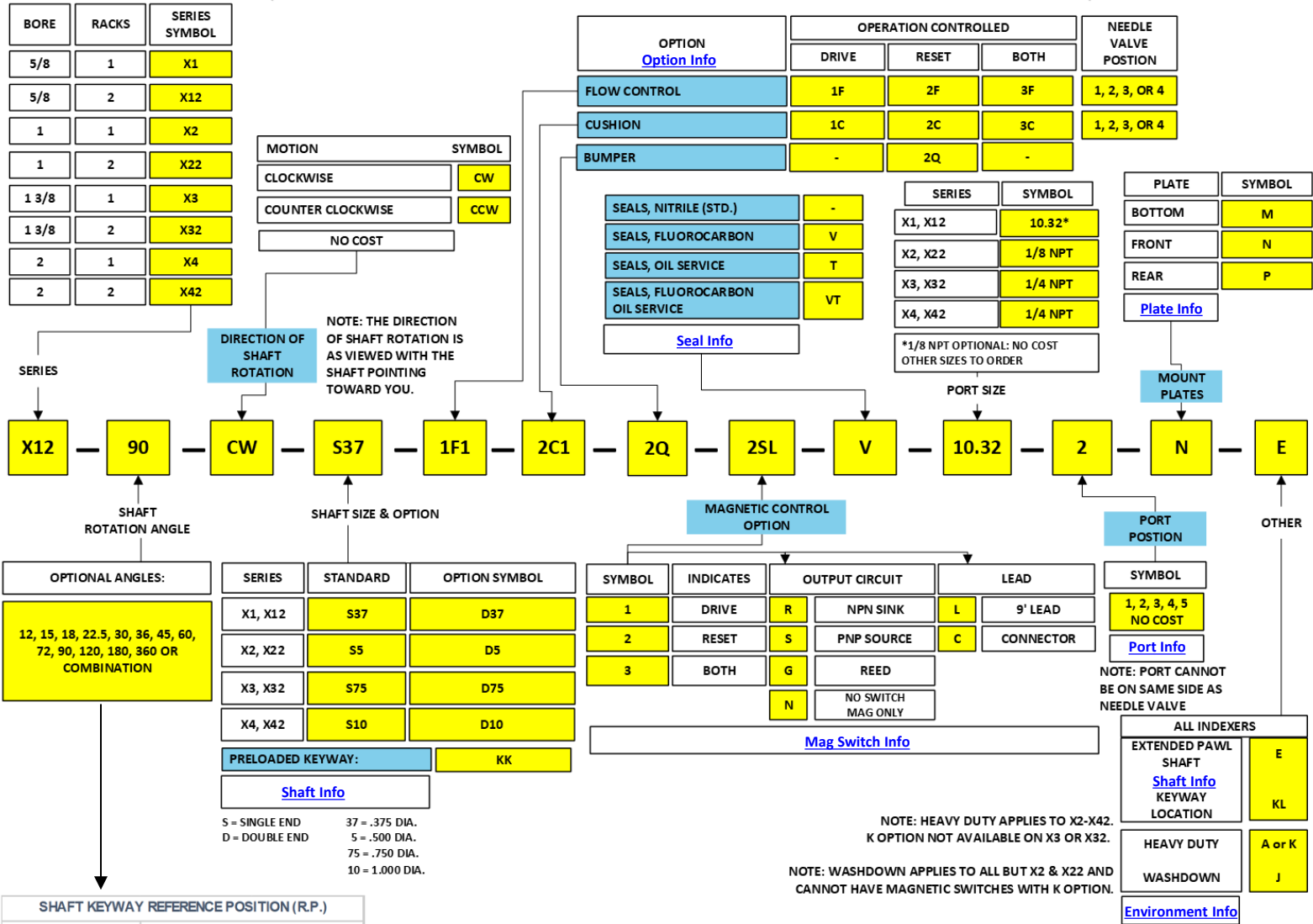

| SHAFT KEYWAY REFERENCE POSITION (R.P.) |                                     |           |
|--|-------------------------------------|-----------|
| INDEXER ROTATION (degrees)             | KEYWAY REFERENCE POSITION (O'clock) | (degrees) |
| 30                                     | 11:30                               | 345       |
| 60                                     | 9:00                                | 270       |
| 120                                    | 6:00                                | 180       |
| All others                             | 12:00                               | 0         |
| REFERENCE POSITION ACCURACY            |                                     | ±2.0°     |
| 'KL' OPTION (HIGH ACCURACY R.P.)       |                                     | ±0.2°     |

The direction of shaft rotation is as viewed with the shaft pointing toward you.

### CALCULATED TORQUE IN INCH-POUNDS

Deduct 10% for friction

| UNIT | MAX PSI | TORQUE FACTOR | OPERATING PRESSURE IN PSI |     |     |     |     |     |
|------|---------|---------------|---------------------------|-----|-----|-----|-----|-----|
|      |         |               | 25                        | 50  | 60  | 80  | 100 | 200 |
| X1   | 250     | 0.153         | 3.8                       | 7.7 | 9.2 | 12  | 15  | 31  |
| X12  | 150     | 0.306         | 7.7                       | 15  | 18  | 24  | 31  | -   |
| X2   | 150     | 0.49          | 12                        | 25  | 29  | 39  | 49  | -   |
| X22  | 75      | 0.98          | 25                        | 49  | 59  | -   | -   | -   |
| X3   | 120     | 1.49          | 37                        | 75  | 89  | 119 | 149 | -   |
| X32  | 60      | 2.98          | 75                        | 149 | 179 | -   | -   | -   |
| X4   | 120     | 3.46          | 87                        | 173 | 208 | 277 | 346 | -   |
| X42  | 60      | 6.92          | 173                       | 346 | 415 | -   | -   | -   |

When an option is not required, leave the box blank.

Rotomation can provide units to almost any configuration. Contact our office for special requirements.

To expedite the order of a duplicate of a prior unit, you can reference the serial or stock number. If the number cannot be read from the label, peel it off and find the number stamped into the body.

Extension cables for magnetic switches with the connector option are available and must be ordered separately ([mag switch info](#)). Switches can be purchased and installed in the field for actuators ordered with the switch only (3N option).



Stepping Actuators provide unidirectional rotation in steps, like indexing actuators, but without the hard stops. This means that they will apply torque for a given amount of rotation and then coast to a stop unless there is something external that stops the load. Unlike competitive products with add-on clutch housings, Rotomation stepping actuators have a fully integrated clutch-bearing assembly for solid support of your load.

Our stepping actuators feature black-anodized aluminum bodies, case hardened precision-ground carbon steel shafts, ball bearings, and stainless-steel hardware.

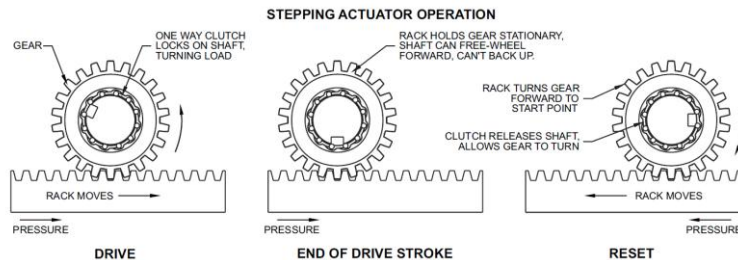

### S1



### S2



### S22



### S3



### S32



### S4



### S42



|     | STANDARD ROTATIONS (degrees) | SHAFT SIZES (dia.)                    | TORQUE (at 80 psi) or as Specified | BALL BEARING RATINGS (lbs.) | PORT SIZE        | AVAILABLE OPTIONS                   |
|-----|------------------------------|---------------------------------------|------------------------------------|-----------------------------|------------------|-------------------------------------|
| S1  | 15 angles, 30 to 730         | Standard: .375"<br>Options: None      | 12 in-lbs.                         | Radial: 305<br>Axial: 76    | 10-32 or 1/8 NPT | A, C, F, MP, MS, Q, T, V, VT        |
| S2  | 15 angles, 30 to 730         | Standard: .500"<br>Options: D .500"   | 39 in-lbs.                         | Radial: 1,030<br>Axial: 257 | 1/8 NPT          | A, C, F, HD, J, MS, Q, T, V, VT     |
| S22 | 15 angles, 30 to 730         | Standard: .500"<br>Options: D .500"   | <b>75 psi MAX</b><br>= 73 in-lbs.  | Radial: 1,030<br>Axial: 257 | 1/8 NPT          | A, C, F, HD, J, MS, Q, T, V, VT     |
| S3  | 15 angles, 30 to 730         | Standard: .750"<br>Options: None      | 119 in-lbs.                        | Radial: 1,030<br>Axial: 257 | 1/4 NPT          | A, C, F, HD, J, MP, MS, Q, T, V, VT |
| S32 | 15 angles, 30 to 730         | Standard: .750"<br>Options: None      | <b>60 psi MAX</b><br>= 179 in-lbs. | Radial: 1,030<br>Axial: 257 | 1/4 NPT          | A, C, F, HD, J, MP, MS, Q, T, V, VT |
| S4  | 15 angles, 30 to 730         | Standard: 1.000"<br>Options: D 1.000" | 277 in-lbs.                        | Radial: 1,160<br>Axial: 290 | 1/4 NPT          | A, C, F, HD, J, MP, MS, Q, T, V, VT |
| S42 | 15 angles, 30 to 730         | Standard: 1.000"<br>Options: D 1.000" | <b>60 psi MAX</b><br>= 415 in-lbs. | Radial: 1,160<br>Axial: 290 | 1/4 NPT          | A, C, F, HD, J, MP, MS, Q, T, V, VT |

#### OPTIONS LEGEND:

**A:** Adjustable Rotation  
**C:** Cushions  
**D:** Double Ended Shafts  
**F:** Flow Controls

**HD:** Heavy Duty (A or K)  
**HS:** Hollow Shaft  
**J:** Washdown Protection  
**MP:** Mount Plates  
**MS:** Magnetic Switches

**Q:** Bumpers  
**T:** Hydraulic Service Seals  
**V:** Fluorocarbon Seals  
**VT:** Fluorocarbon Hydraulic Service Seals



# DESIGN YOUR STEPPER



## REQUEST A CAD

## UNIDIRECTIONAL

| BORE  | RACKS | SERIES SYMBOL |
|-------|-------|---------------|
| 5/8   | 1     | S1            |
| 1     | 1     | S2            |
| 1     | 2     | S22           |
| 1 3/8 | 1     | S3            |
| 1 3/8 | 2     | S32           |
| 2     | 1     | S4            |
| 2     | 2     | S42           |

| MOTION            | SYMBOL |
|-------------------|--------|
| CLOCKWISE         | CW     |
| COUNTER CLOCKWISE | CCW    |
| NO COST           |        |

| OPTIONS             | DRIVE | RESET | BOTH |
|---------------------|-------|-------|------|
| FLOW CONTROL        | 1F    | 2F    | 3F   |
| CUSHION             | 1C    | 2C    | 3C   |
| BUMPER              | 1Q    | 2Q    | 3Q   |
| ADJUSTABLE ROTATION | 1A    | 2A    | 3A   |

| SEALS, NITRILE (STD.)           | SYMBOL |
|---------------------------------|--------|
| SEALS, NITRILE (STD.)           | -      |
| SEALS, FLUOROCARBON             | V      |
| SEALS, OIL SERVICE              | T      |
| SEALS, FLUOROCARBON OIL SERVICE | VT     |

| SERIES  | SYMBOL  |
|---------|---------|
| S1      | 10.32*  |
| S2, S22 | 1/8 NPT |
| S3, S32 | 1/4 NPT |
| S4, S42 | 1/4 NPT |

| PLATE  | SYMBOL |
|--------|--------|
| BOTTOM | M      |
| FRONT  | N      |
| REAR   | P      |

| OPTIONAL ANGLES:   |
|--|
| 30, 45, 60, 90, 100, 120, 180, 190, 270, 360, 370, 540, 550, 720, 730, OR AS SPECIFIED |

| SERIES  | STANDARD | OPTION SYMBOL |
|---------|----------|---------------|
| S1      | S37      | -             |
| S2, S22 | S5       | D5            |
| S3, S32 | S75      | -             |
| S4, S42 | S10      | D10           |

| SYMBOL | INDICATES | OUTPUT CIRCUIT       | LEAD        |
|--------|-----------|----------------------|-------------|
| 1      | DRIVE     | R NPN SINK           | L 9' LEAD   |
| 2      | RESET     | S PNP SOURCE         | C CONNECTOR |
| 3      | BOTH      | G REED               |             |
| 3      | BOTH      | N NO SWITCH MAG ONLY |             |

| SERIES  | SYMBOL  |
|---------|---------|
| S1      | 10.32*  |
| S2, S22 | 1/8 NPT |
| S3, S32 | 1/4 NPT |
| S4, S42 | 1/4 NPT |

| PORT POSITION | SYMBOL        |
|---------------|---------------|
| 1, 2, 3, OR 4 | 1, 2, 3, OR 4 |
| 1, 2, 3, 4, 5 | 1, 2, 3, 4, 5 |

**NOTE: FLOW CONTROL & CUSHION CANNOT BE INSTALLED IN SAME END CAP.**

**NOTE: THE DIRECTION OF SHAFT ROTATION IS AS VIEWED WITH THE SHAFT POINTING TOWARD YOU.**

**NOTE: REED SWITCH NOT AVAILABLE ON S1.**

**NOTE: PORT CANNOT BE ON SAME SIDE AS NEEDLE VALVE.**

**HEAVY DUTY: A OR K N/A ON S1**

**WASHDOWN: J N/A FOR S37, D37, & D10**

### CALCULATED TORQUE IN INCH-POUNDS

Deduct 10% for friction

| UNIT | MAX PSI | TORQUE FACTOR | OPERATING PRESSURE IN PSI |     |     |     |     |     |
|------|---------|---------------|---------------------------|-----|-----|-----|-----|-----|
|      |         |               | 25                        | 50  | 60  | 80  | 100 | 200 |
| S1   | 250     | 0.153         | 3.8                       | 7.7 | 9.2 | 12  | 15  | 31  |
| S2   | 150     | 0.49          | 12                        | 25  | 29  | 39  | 49  | -   |
| S22  | 75      | 0.98          | 25                        | 49  | 59  | -   | -   | -   |
| S3   | 120     | 1.49          | 37                        | 75  | 89  | 119 | 149 | -   |
| S32  | 60      | 2.98          | 75                        | 149 | 179 | -   | -   | -   |
| S4   | 120     | 3.46          | 87                        | 173 | 208 | 277 | 346 | -   |
| S42  | 60      | 6.92          | 173                       | 346 | 415 | -   | -   | -   |

When an option is not required, leave the box blank.

Rotomation can provide units to almost any configuration. Contact our office for special requirements.

To expedite the order of a duplicate of a prior unit, you can reference the serial or stock number. If the number cannot be read from the label, peel it off and find the number stamped into the body.

Extension cables for magnetic switches with the connector option are available and must be ordered separately ([mag switch info](#)). Switches can be purchased and installed in the field for actuators ordered with the switch only (3N option).

### SEAL REPAIR KIT INFO



386-676-6377



rotomation.com



sales@rotomation.com

# ROTARY ACTUATORS MULTI-MOTION & NITPICKERS







Multi-motion actuators (for pick & place operations) combine a rotary section with a linear cylinder to provide independently-controlled linear and rotary motion. The PA series utilizes our standard rotary actuators to provide the rotary motion, but we can also provide indexing or stepping rotary motion in certain cases. For these, please contact the factory.

You can configure the rotary section with the same options as our standard rotary devices. Linear options include stroke, stop tubes for added stability, magnetic switches, and your choice of two rod ends including the B option which is compatible with our Shaft Mounting Adapters.

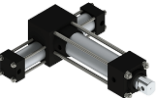
All Rotomation multi-motion actuators feature black-anodized aluminum bodies, Stressproof™ steel rods, ball bearings, and stainless steel hardware.

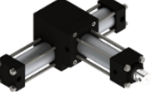
Our Nitpicker actuators are fully rebuildable and designed for general applications requiring independently-controlled combined linear and indexing motion on a single unit.

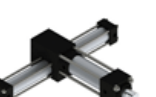
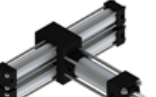
|   | STANDARD ROTATIONS (degrees)                 | ROD DIAMETER                      | TORQUE (at 80 psi)   | LINEAR FORCE (at 80 psi)                                   | PORT SIZE | AVAILABLE OPTIONS               |
|---|--|-----------------------------------|--|--|-----------|---------------------------------|
| <a href="#">PA01</a><br>   | 15 angles, 30 to 730                         | Standard: .375"<br>Options: None  | 5 in-lbs. @ extended, 6 in-lbs. @ retracted                          | Extend: 25 lbs.<br>Retract: 15 lbs.                        | 10-32     | A, C, F, MP, MS, Q, T, V, VT    |
| <a href="#">PA2</a><br>   | 15 angles, 30 to 730                         | Standard: 1.000"<br>Options: None | 24 in-lbs. @ extended, 34 in-lbs. @ retracted                        | Extend: 118 lbs.<br>Retract: 56 lbs.                       | 1/8 NPT   | A, C, F, J, MP, MS, Q, T, V, VT |
| <a href="#">PA22</a><br> | 15 angles, 30 to 730                         | Standard: 1.000"<br>Options: None | 63 in-lbs. @ extended, 73 in-lbs. @ retracted                        | Extend: 118 lbs.<br>Retract: 56 lbs.                       | 1/8 NPT   | A, C, F, J, MP, MS, Q, T, V, VT |
| <a href="#">PA3</a><br>  | 15 angles, 30 to 730                         | Standard: 1.000"<br>Options: None | 104 in-lbs. @ extended, 114 in-lbs. @ retracted                      | Extend: 118 lbs.<br>Retract: 56 lbs.                       | 1/4 NPT   | A, C, F, J, MP, MS, Q, T, V, VT |
| <a href="#">PA32</a><br> | 15 angles, 30 to 730                         | Standard: 1.000"<br>Options: None | 192 in-lbs. @ extended, 221 in-lbs. @ retracted                      | Extend: 118 lbs.<br>Retract: 56 lbs.                       | 1/4 NPT   | A, C, F, J, MP, MS, Q, T, V, VT |
| <a href="#">PX2</a><br>  | From 12 (30 steps/rev.) to 360 (1 step/rev.) | Standard: 1.000"<br>Options: None | 24 in-lbs. @ extended, 34 in-lbs. @ retracted                        | Extend: 118 lbs.<br>Retract: 56 lbs.                       | 1/8 NPT   | C, F, HD, MP, MS, Q, T, V, VT   |
| <a href="#">PX22</a><br> | From 12 (30 steps/rev.) to 360 (1 step/rev.) | Standard: 1.000"<br>Options: None | <b>75 psi MAX =</b><br>47 in-lbs. @ extended, 55 in-lbs. @ retracted | <b>75 psi MAX =</b><br>Extend: 89 lbs.<br>Retract: 42 lbs. | 1/8 NPT   | C, F, HD, MP, MS, Q, T, V, VT   |

### 3, 4, & 5 Position for Multi-motion Rotary Actuators Available by Request

#### OPTIONS LEGEND:

**A:** Adjustable Rotation  
**C:** Cushions  
**D:** Double Ended Shafts  
**F:** Flow Controls

**HD:** Heavy Duty (A or K)  
**HS:** Hollow Shaft  
**J:** Washdown Protection  
**MP:** Mount Plates  
**MS:** Magnetic Switches

**Q:** Bumpers  
**T:** Hydraulic Service Seals  
**V:** Fluorocarbon Seals  
**VT:** Fluorocarbon Hydraulic Service Seals



386-676-6377



rotomation.com



sales@rotomation.com

# DESIGN YOUR MULTI-MOTION



## LINEAR & ROTARY

### CONFIGURATOR LINK

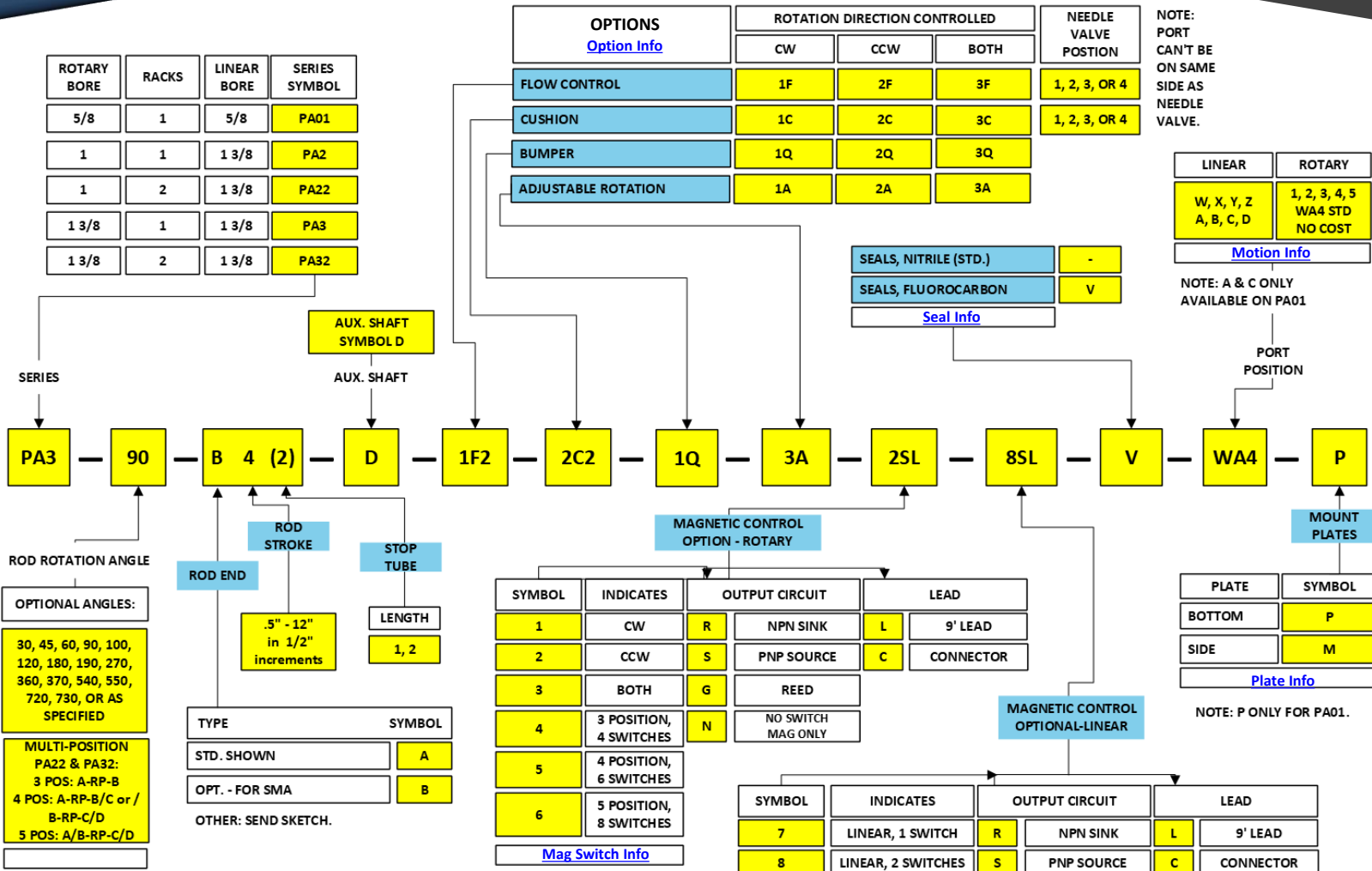

### CALCULATED ROTARY TORQUE IN INCH-POUNDS

Deduct 10% for Friction

| MAX PSI | TORQUE FACTOR | OPERATING PRESSURE IN PSI |    |     |     |     |     |     |
|---------|---------------|---------------------------|----|-----|-----|-----|-----|-----|
|         |               | 25                        | 50 | 60  | 80  | 100 | 200 |     |
| PA01    | EXTENDED      | 0.058                     | 1  | 3   | 3   | 5   | 6   | -   |
|         | RETRACTED     | 0.066                     | 2  | 3   | 4   | 5   | 7   | -   |
| PA2     | EXTENDED      | 0.300                     | 8  | 15  | 18  | 24  | 30  | 60  |
|         | RETRACTED     | 0.420                     | 11 | 21  | 25  | 34  | 42  | 84  |
| PA22    | EXTENDED      | 0.790                     | 20 | 40  | 47  | 63  | 79  | 158 |
|         | RETRACTED     | 0.910                     | 23 | 46  | 55  | 73  | 91  | 182 |
| PA3     | EXTENDED      | 1.300                     | 33 | 65  | 78  | 104 | 130 | 260 |
|         | RETRACTED     | 1.420                     | 36 | 71  | 85  | 114 | 142 | 284 |
| PA32    | EXTENDED      | 2.790                     | 70 | 140 | 167 | 223 | 279 | 558 |
|         | RETRACTED     | 2.910                     | 73 | 146 | 175 | 233 | 291 | 582 |

### CALCULATED LINEAR FORCE IN POUNDS

Deduct 10% for Friction

| MAX PSI | FORCE FACTOR | OPERATING PRESSURE IN PSI |    |    |    |     |     |     |
|---------|--------------|---------------------------|----|----|----|-----|-----|-----|
|         |              | 25                        | 50 | 60 | 80 | 100 | 200 |     |
| PA01    | PUSH         | 0.310                     | 8  | 16 | 19 | 25  | 31  | -   |
|         | PULL         | 0.190                     | 5  | 10 | 11 | 15  | 19  | -   |
| PA2     | PUSH         | 1.480                     | 37 | 74 | 89 | 118 | 148 | 296 |
|         | PULL         | 0.700                     | 18 | 35 | 42 | 56  | 70  | 140 |
| PA22    | PUSH         | 1.480                     | 37 | 74 | 89 | 118 | 148 | 296 |
|         | PULL         | 0.700                     | 18 | 35 | 42 | 56  | 70  | 140 |
| PA3     | PUSH         | 1.480                     | 37 | 74 | 89 | 118 | 148 | 296 |
|         | PULL         | 0.700                     | 18 | 35 | 42 | 56  | 70  | 140 |
| PA32    | PUSH         | 1.480                     | 37 | 74 | 89 | 118 | 148 | 296 |
|         | PULL         | 0.700                     | 18 | 35 | 42 | 56  | 70  | 140 |

When an option is not required, leave the box blank.

Rotomation can provide units to almost any configuration. Contact our office for special requirements.

To expedite the order of a duplicate of a prior unit, you can reference the serial or stock number. If the number cannot be read from the label, peel it off and find the number stamped into the body.

Extension cables for magnetic switches with the connector option are available and must be ordered separately ([mag switch info](#)). Switches can be purchased and installed in the field for actuators ordered with the switch only (3N option).

### SEAL REPAIR KIT INFO

To provide an indexing rotary motion combined with a linear motion, consider the Nitpicker that combines the X2 or X22 rotary drive with the linear motion facility of the PA2 or PA22.

The configuration is similar to the PA2 or PA22. For specification and ordering details contact our office and ask for the Nitpicker design chart. Functions and options are similar to those outlined above but have rotary characteristics of the X2 and X22.

# DESIGN YOUR NITPICKER



LINEAR & ROTARY

[Link to CAD request form \(nitpicker is not included in current configurator\)](#)

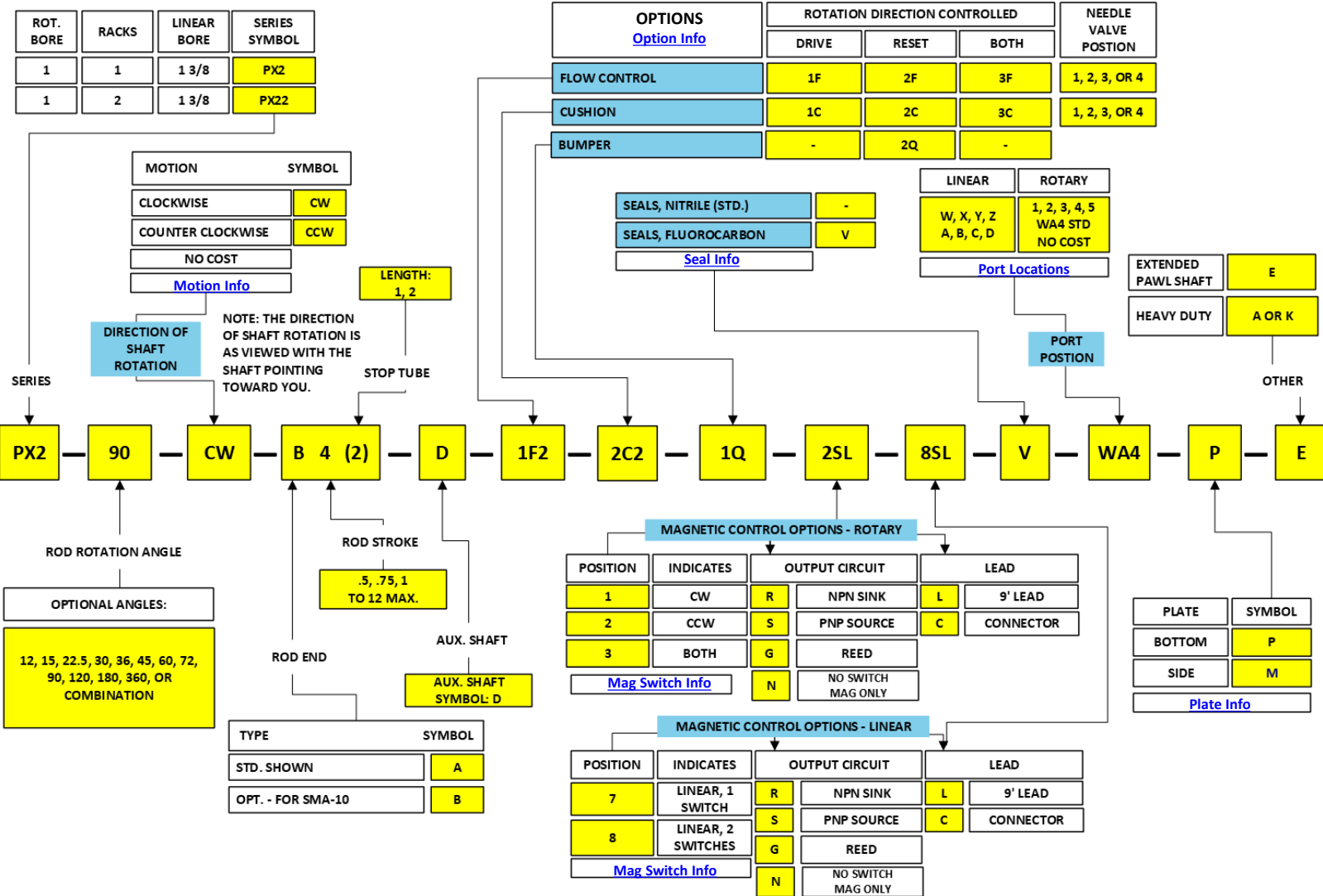

|         |               | CALCULATED NON SHOCK ROTARY TORQUE IN INCH-POUNDS |                           |       |    |    |     |     |    |   |
|---------|---------------|---|---------------------------|-------|----|----|-----|-----|----|---|
|         |               | Deduct 10% for Friction                           |                           |       |    |    |     |     |    |   |
| MAX PSI | TORQUE FACTOR | Max TORQUE  | OPERATING PRESSURE IN PSI |       |    |    |     |     |    |   |
|         |               |   | 25                        | 50    | 60 | 80 | 100 | 200 |    |   |
| PX2     | EXTENDED      | 150   | 0.30                      | 45.00 | 8  | 15 | 18  | 24  | 30 | - |
|         | RETRACTED     |   | 0.42                      | 63.00 | 11 | 21 | 25  | 34  | 42 | - |
| PX22    | EXTENDED      | 75  | 0.79                      | 59.25 | 20 | 40 | 47  | -   | -  | - |
|         | RETRACTED     |   | 0.91                      | 68.25 | 23 | 46 | 55  | -   | -  | - |

|         |              | CALCULATED LINEAR FORCE IN POUNDS |                           |        |    |    |     |     |     |   |
|---------|--------------|-----------------------------------|---------------------------|--------|----|----|-----|-----|-----|---|
|         |              | Deduct 10% for Friction           |                           |        |    |    |     |     |     |   |
| MAX PSI | FORCE FACTOR | Max TORQUE                        | OPERATING PRESSURE IN PSI |        |    |    |     |     |     |   |
|         |              |                                   | 25                        | 50     | 60 | 80 | 100 | 200 |     |   |
| PX2     | PUSH         | 150                               | 1.48                      | 222.00 | 37 | 74 | 89  | 118 | 148 | - |
|         | PULL         |                                   | 0.70                      | 105.00 | 18 | 35 | 42  | 56  | 70  | - |
| PX22    | PUSH         | 75                                | 1.48                      | 111.00 | 37 | 74 | 89  | -   | -   | - |
|         | PULL         |                                   | 0.70                      | 52.50  | 18 | 35 | 42  | -   | -   | - |

When an option is not required, leave the box blank.

Rotomation can provide units to almost any configuration. Contact our office for special requirements.

To expedite the order of a duplicate of a prior unit, you can reference the serial or stock number. If the number cannot be read from the label, peel it off and find the number stamped into the body.

Extension cables for magnetic switches with the connector option are available and must be ordered separately ([mag switch info](#)). Switches can be purchased and installed in the field for actuators ordered with the switch only (3N option).

[SEAL REPAIR KIT INFO](#)

# GENERAL AND MOTION CONTROL OPTIONS FOR ROTOMATION

## ROTARY, INDEXING, AND STEPPING ACTUATORS

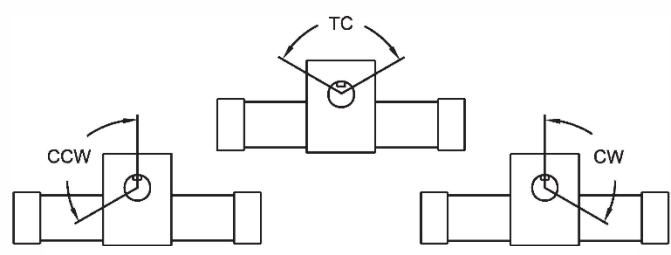

### ROTARY ACTUATOR SHAFT KEYWAY CLOCKING

Symbols specify orientation of arc of motion looking at front of unit. In Top Center (TC), the keyway passes thru 12:00 o'clock (0 deg.) at the midpoint of rotation; one-half the rotation is on either side of 12:00 o'clock.

Symbol: TC, CW, CCW NO COST OPTION

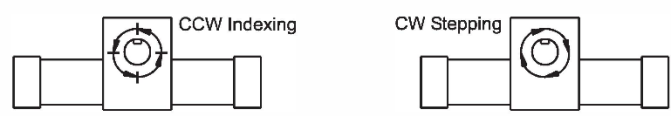

### INDEXING & STEPPING ACTUATOR SHAFT KEYWAY MOTION

Specify shaft rotation looking at the projecting, load-carrying shaft.

Symbol: CW, CCW No cost option.

Indexing actuator: steps in specified direction to hard stops.  
Stepping actuator: steps in specified direction, no hard stops. Accumulates error.

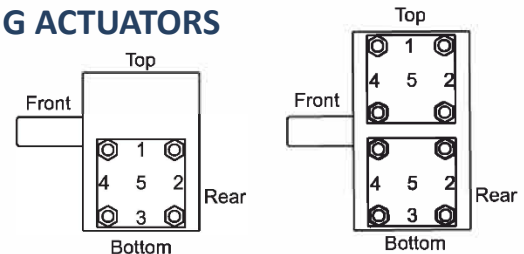

### PORT AND NEEDLE POSITIONS

Use numbered locations to specify desired position. Position 5 is not available with options A, Q, F, or C. Needles cannot be at position 5 or in same location as port, and are normally located on upper rack of two rack actuators except multi-position. Dual rack actuators cannot have ports between end caps; specify positions 2, 4, or 1,3.

NO COST OPTION

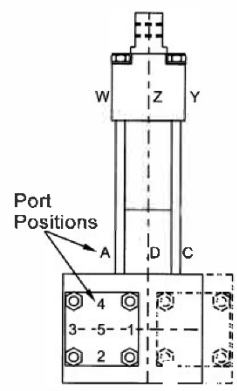

For pick and place actuators, also specify linear port locations: at rod cap use W, X, Y, or Z. Bottom port is A, B, C, or D (A or C only for PA01).

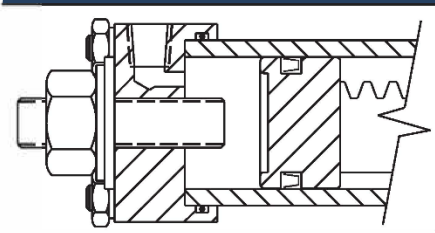

### ROTATION ADJUSTER

Adjustable stop controls rotation over 30 deg. range by stroke reduction.  
Can be combined with flow control or cushion in single rack actuators or steppers.  
Not available for indexers.

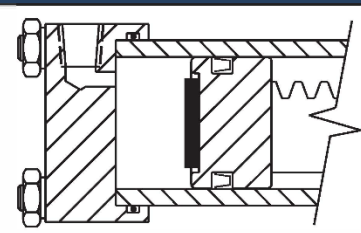

### BUMPER

A urethane bumper is fastened to the piston face. It eliminates metal to metal contact and absorbs shock. Requires added cylinder length.

Symbol: Q

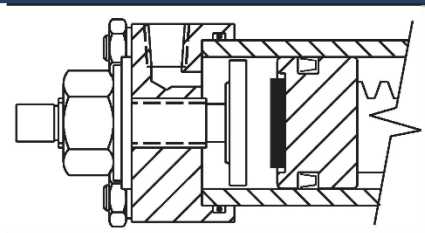

### ADJUSTER AND BUMPER

Combination of adjuster and bumper. Uses enlarged adjuster face to distribute impact. Requires added cylinder length.

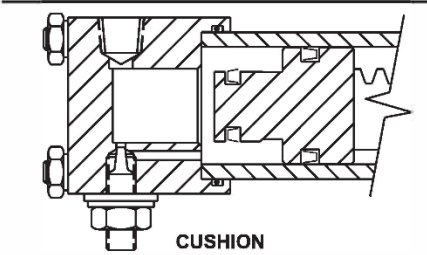

### CUSHION

A reversed U-cup on the auxiliary piston closes the free passage to the port, forces exhaust through the control needle valve over last 30 deg. of rotation. For return, pressure folds U-cup down, allows full pressure and flow to piston.

Not fully effective in drive direction in steppers or indexers because of overrunning clutch.

Symbol: C

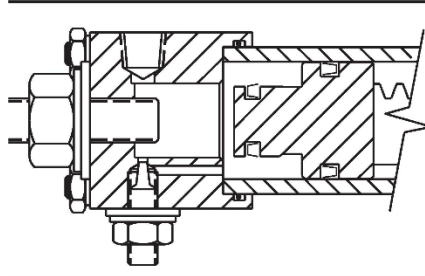

### ADJUSTER AND CUSHION

Combined adjuster and cushion for single rack actuators or steppers. Installed separately, cushion on top rack, in dual rack units. Stroke reduction also reduces cushion action.

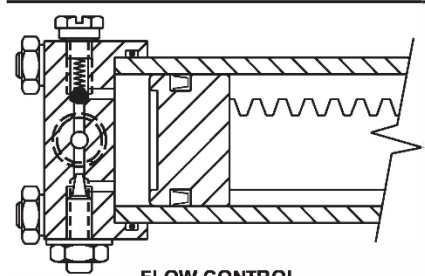

### FLOW CONTROL

Forces exhausting air to pass through control needle valve, limits operating speed throughout rotation in one direction. Check valve opens for full flow on return. Requires needle valve access; not available with port position 5. Intended primarily for air operation. Can be combined with rotation adjustment or bumper.

Symbol: F

# GENERAL AND MOTION CONTROL OPTIONS FOR A032 2 & 3 POSITION

## A032 2-POSITION

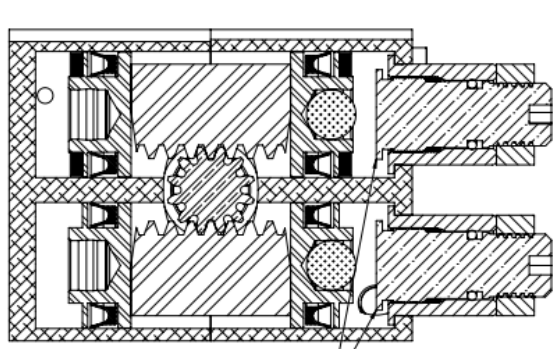

**ADJUSTER OPTION**

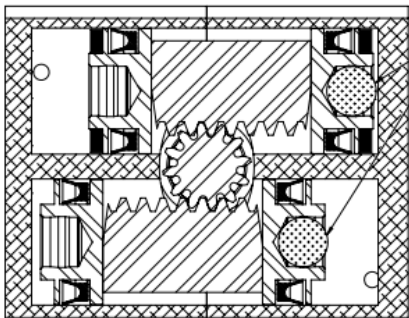

**BUMPER OPTION**

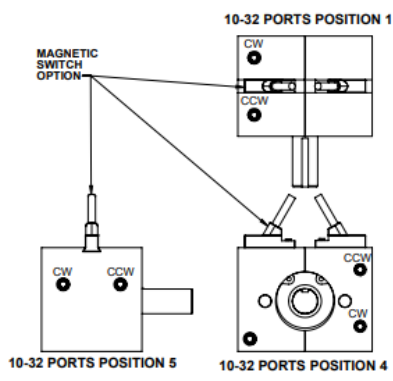

**PORT POSITIONS 1, 4 & 5**  
USE NUMBERED LOCATIONS TO SPECIFY DESIRED POSITION. EXTERNAL FLOW CONTROLS REQUIRED FOR SPEED ADJUSTMENT.

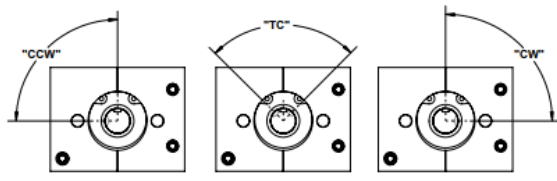

**ACTUATOR SHAFT KEYWAY MOTION**  
SYMBOLS SPECIFY ORIENTATION OF ARC OF MOTION AS ABOVE  
SYMBOL: TC, CW, CCW NO COST OPTIONS  
STANDARD ROTATIONS ARE 30, 45, 60, 90, 100, 120, 180 AND 190 DEG.  
SPECIAL ANGLE CAN BE SPECIFIED (190 MAX)

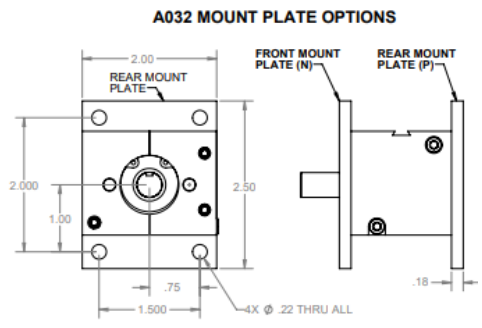

## A032 3-POSITION

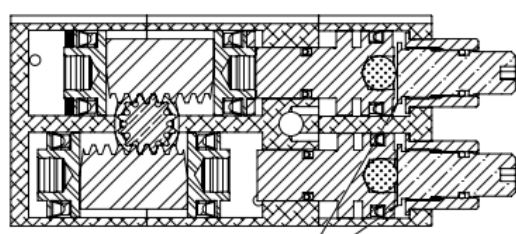

**ADJUSTER OPTION**

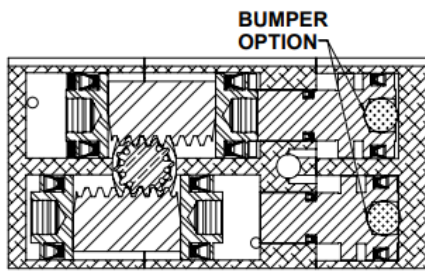

**BUMPER OPTION**

**A032 3 POSITION SHAFT ROTATION OPTIONS**  
PROVIDES DRIVE TO ANY THREE SHAFT POSITIONS BY USE OF BUILT-IN AUXILIARY CYLINDERS AND PISTONS. TORQUE FOR THE MOTION TO CENTER IS ONE-HALF TOTAL TORQUE BUT CAN BE INCREASED BY SPECIAL VALVE ARRANGEMENT.  
OPTIONAL ANGLES 45-6-45 OR 50-6-50 OR 90-6-90 OR 100-6-100  
CONSULT FACTORY FOR SPECIAL ANGLE COMBINATIONS

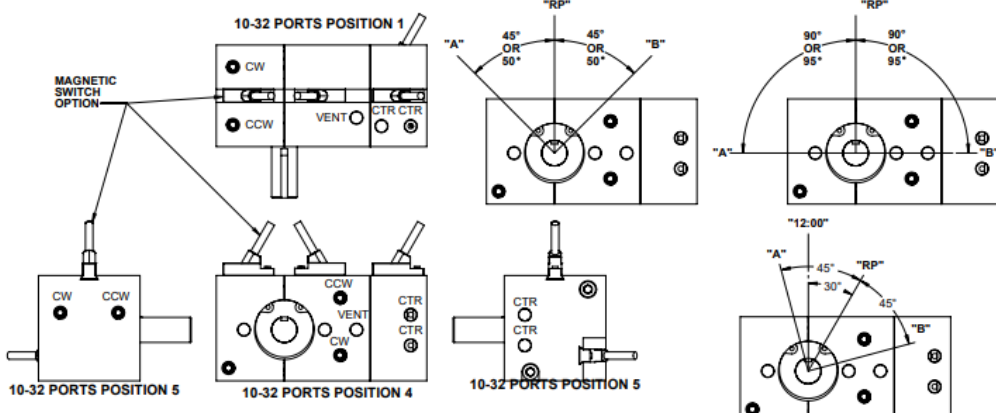

**PORT POSITIONS 1, 4 & 5**  
USE NUMBERED LOCATIONS TO SPECIFY DESIRED POSITION. EXTERNAL FLOW CONTROLS REQUIRED FOR SPEED ADJUSTMENT.

FOR NON-CENTERED ROTATION RP IS SPECIFIED IN DEGREES CW OF “12:00”  
EXAMPLE SHOWN ABOVE WOULD BE 45-30-45

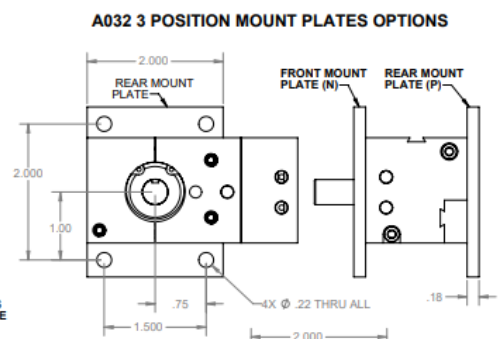

## GENERAL AND MOTION CONTROL OPTIONS FOR AL75 AND A752

### AL75

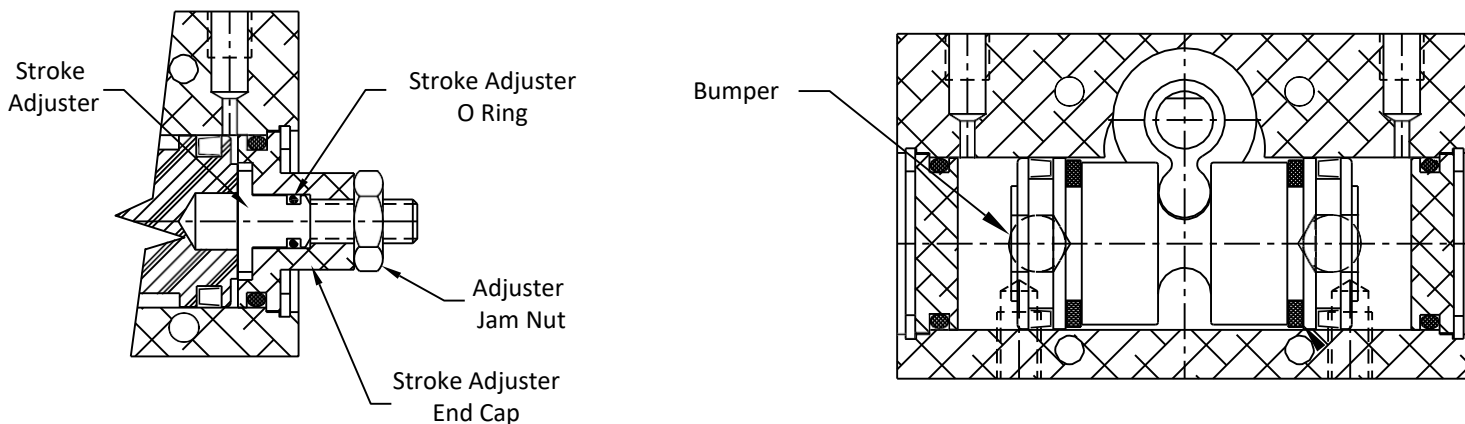

### A752

#### PORT POSITIONS 1, 2, 3, 4, 5 NEEDLE VALVE POSITIONS 1, 2, 3, 4

PORT & NEEDLE VALVE CANNOT BE AT THE SAME POSITION

Use numbered locations to specify desired position. No port in position 5 with options A, F, or C. No port or needle valve between end caps; for positions 90 from shaft, specify 1, 3 (top and bottom)

#### OPTIONAL SHAFT CONFIGURATIONS

| UNIT SYMBOL | SHAFT SYMBOL | SHAFT O.D. | KEYWAY      | SHAFT I.D.  | SET SCREW | STD. BEARING | SHAFT PROJ. P |
|-------------|--------------|------------|-------------|-------------|-----------|--------------|---------------|
| A752        | S37          | .375       | 3/32 X 3/64 |             |           | BALL         | 7/8           |
|             | D37          | .375       | 3/32 X 3/64 |             |           | BALL         | 7/8           |
|             | HS37         | .625       | 3/32 X 3/64 | .3755/.3765 | 8-32      | BRONZE       | 1/4           |

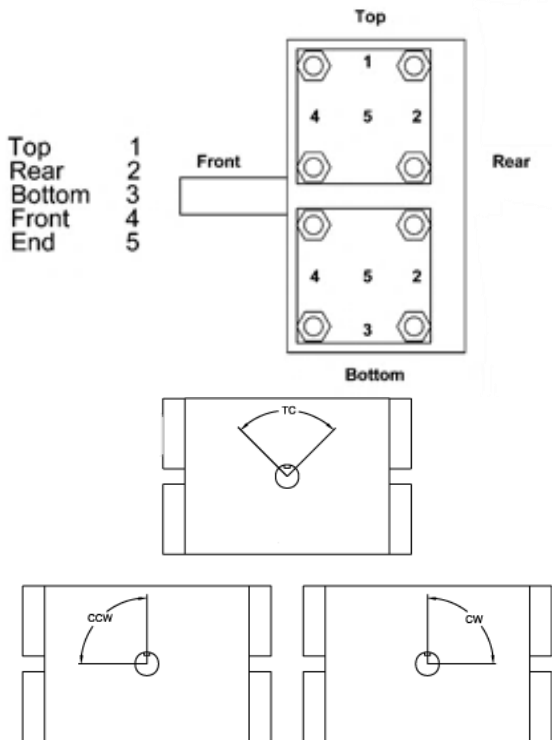

ACTUATOR SHAFT KEYWAY MOTION

Symbols specify orientation of arc of motion as above.  
Symbol: TC, CW, CCW No cost option.

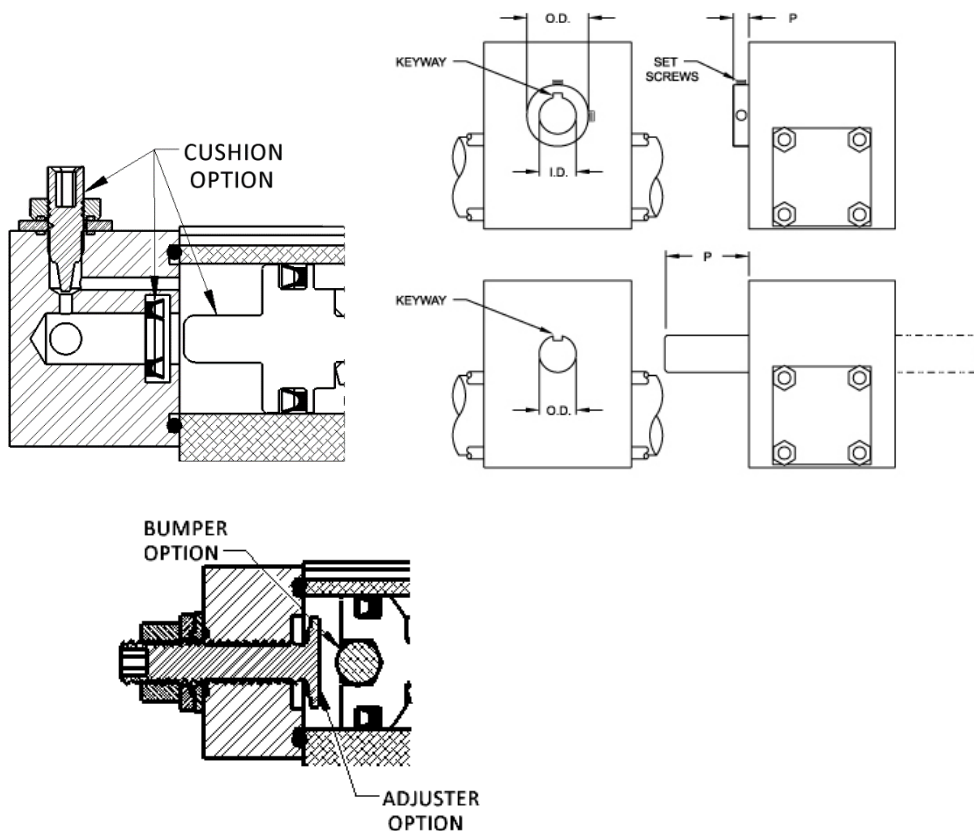

## GENERAL AND MOTION CONTROL OPTIONS FOR MULTI-MOTION AND NITPICKER

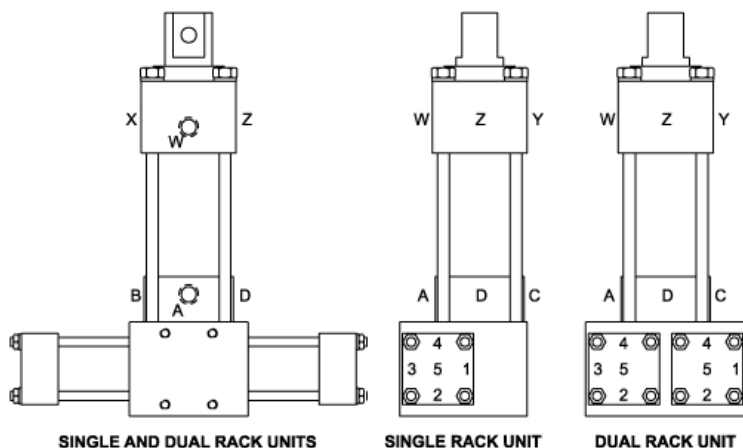

SINGLE AND DUAL RACK UNITS

SINGLE RACK UNIT

DUAL RACK UNIT

PORT POSITIONS 1, 2, 3, 4, 5  
NEEDLE VALVE POSITIONS 1, 2, 3, 4  
(PORT & NEEDLE VALVE CANNOT BE AT SAME POSITION)

Use numbered/lettered locations to specify desired positions. No port in position 5 with options A, F or C. No port or needle valve between end caps in dual rack units.

### Rod End Standard Option A

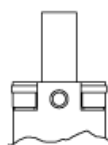

STANDARD ROD END  
SERIES PA01

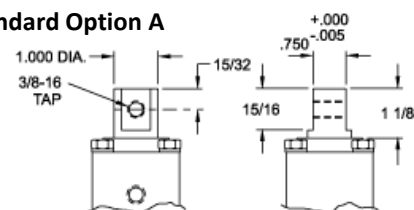
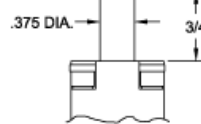

STANDARD ROD END  
SERIES PA2, PA22, PA3 & PA32

### Rod End Standard Option B

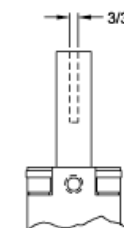

OPTIONAL ROD END (WORKS WITH SMA-37)  
SHOWN AT MIDPOINT OF ROTATION

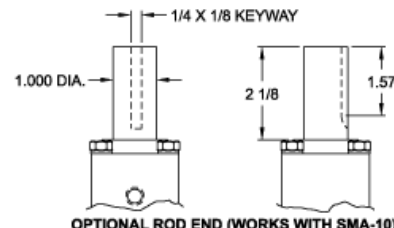

OPTIONAL ROD END (WORKS WITH SMA-10)  
SHOWN AT MIDPOINT OF ROTATION

## MULTI-MOTION AND NITPICKER MOUNTING PLATES

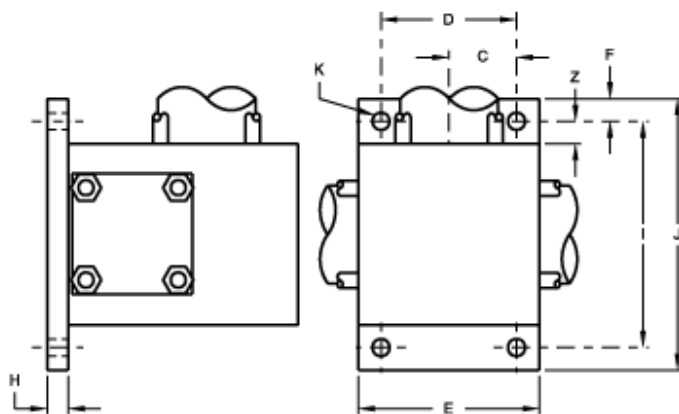

SIDE PLATE  
SYMBOL: M

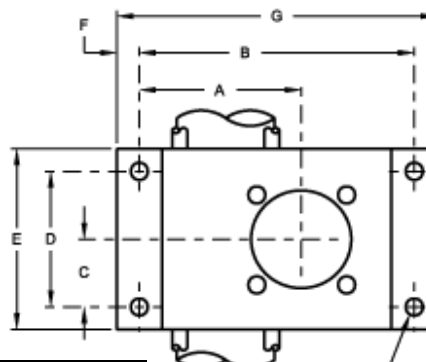

BASE PLATE  
SYMBOL: P

| MODEL | A     | B     | C     | D    | E    | F   | G    | H    | I     | J    | K     | Z    |
|-------|-------|-------|-------|------|------|-----|------|------|-------|------|-------|------|
| PA01  | 1.312 | 2     | .750  | 1.5  | 2    | 1/4 | 2.5  | .175 | -     | -    | 13/64 | .188 |
| PA2   | 1.938 | 3.188 | .750  | 1.5  | 2.50 | 1/4 | 3.69 | .235 | 2.500 | 3.00 | 7/32  | .250 |
| PA22  | 1.938 | 3.875 | .750  | 1.5  | 2.50 | 1/4 | 4.38 | .235 | 2.500 | 3.00 | 7/32  | .250 |
| PA3   | 2.687 | 4.562 | 1.125 | 2.25 | 3.00 | 3/8 | 5.31 | .350 | 3.750 | 4.50 | 9/32  | .375 |
| PA32  | 2.687 | 5.375 | 1.125 | 2.25 | 3.00 | 3/8 | 6.13 | .350 | 3.750 | 4.50 | 9/32  | .375 |
| PX2   | 1.938 | 3.188 | .750  | 1.5  | 2.00 | 1/4 | 3.69 | .235 | 3.500 | 4.00 | 7/32  | .250 |
| PX22  | 1.938 | 3.875 | .750  | 1.5  | 2.00 | 1/4 | 4.38 | .235 | 3.500 | 4.00 | 7/32  | .250 |

NOTE: Mount plates provide flange type mounting with through holes for blind hole mounting.

NOTE: Mount plate P (perpendicular to rod) same as the listed plate for corresponding actuator or indexer.

## MOUNT PLATE OPTIONS FOR ROTOMATION ROTARY, INDEXING, AND STEPPING ACTUATORS

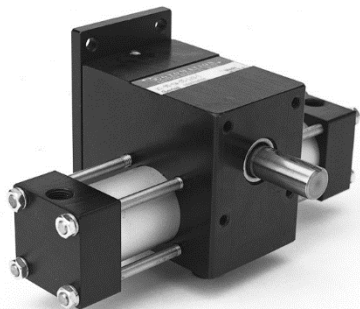

REAR MOUNT PLATE P

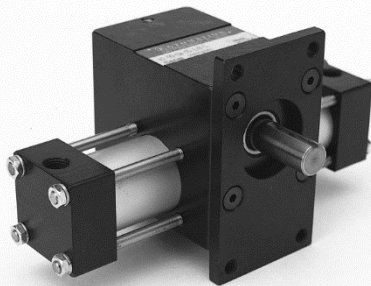

FRONT MOUNT PLATE N

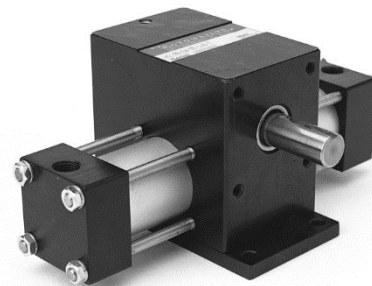

BOTTOM MOUNT PLATE M

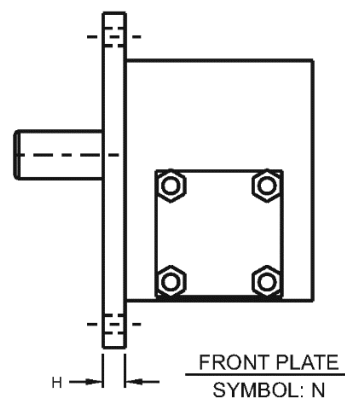
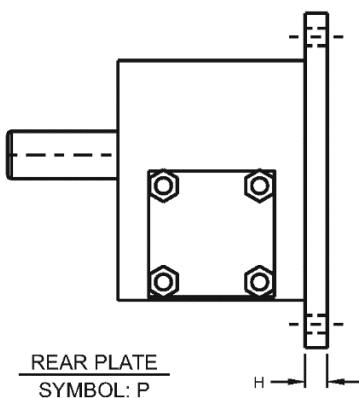
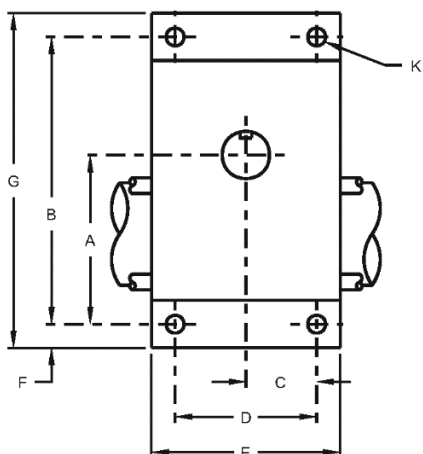

### DIMENSIONS

|          | A     | B     | C     | D     | E    | F    | G    | H    | I     | J    | K     | Z    |
|----------|-------|-------|-------|-------|------|------|------|------|-------|------|-------|------|
| A01      | 1.188 | 1.875 | .313  | .625  | 1.00 | .187 | 2.25 | .175 | 1.375 | 1.75 | .187  | .188 |
| A1       | 1.500 | 2.500 | .750  | 1.500 | 2.00 | .250 | 3.00 | .175 | 2.500 | 3.00 | 7/32  | .563 |
| S1       | 1.500 | 2.500 | .750  | 1.500 | 2.00 | .250 | 3.00 | .175 | 3.125 | 3.63 | 7/32  | .563 |
| A12      | 1.500 | 3.000 | .750  | 1.500 | 2.00 | .250 | 3.50 | .175 | 2.500 | 3.00 | 7/32  | .563 |
| X1       | 1.500 | 2.500 | .750  | 1.500 | 2.00 | .250 | 3.00 | .175 | 3.125 | 3.63 | 7/32  | .250 |
| X12      | 1.500 | 3.000 | .750  | 1.500 | 2.00 | .250 | 3.50 | .175 | 3.125 | 3.63 | 7/32  | .250 |
| A2 or S2 | 1.938 | 3.188 | .750  | 1.500 | 2.50 | .250 | 3.69 | .235 | 2.500 | 3.00 | 7/32  | .250 |
| A22      | 1.938 | 3.875 | .750  | 1.500 | 2.50 | .250 | 4.38 | .235 | 2.500 | 3.00 | 7/32  | .250 |
| X2       | 1.938 | 3.188 | .750  | 1.500 | 2.00 | .250 | 3.69 | .235 | 3.500 | 4.00 | 7/32  | .250 |
| X22      | 1.938 | 3.875 | .750  | 1.500 | 2.00 | .250 | 4.38 | .235 | 3.500 | 4.00 | 7/32  | .250 |
| A3 or S3 | 2.687 | 4.562 | 1.125 | 2.250 | 3.00 | .375 | 5.31 | .350 | 3.750 | 4.50 | 9/32  | .375 |
| A32      | 2.687 | 5.375 | 1.125 | 2.250 | 3.00 | .375 | 6.13 | .350 | 3.750 | 4.50 | 9/32  | .375 |
| X3       | 2.687 | 4.562 | 1.125 | 2.250 | 3.00 | .375 | 5.31 | .350 | 4.500 | 5.25 | 9/32  | .375 |
| A4 or S4 | 3.125 | 5.063 | 1.125 | 2.250 | 3.00 | .375 | 5.81 | .350 | 3.750 | 4.50 | 11/32 | .375 |
| A42      | 3.125 | 6.25  | 1.125 | 2.250 | 3.00 | .375 | 7.00 | .350 | 3.75  | 4.50 | 11/32 | .375 |
| X4       | 3.125 | 5.063 | 1.125 | 2.250 | 3.00 | .375 | 5.81 | .350 | 4.75  | 5.50 | 11/32 | .375 |

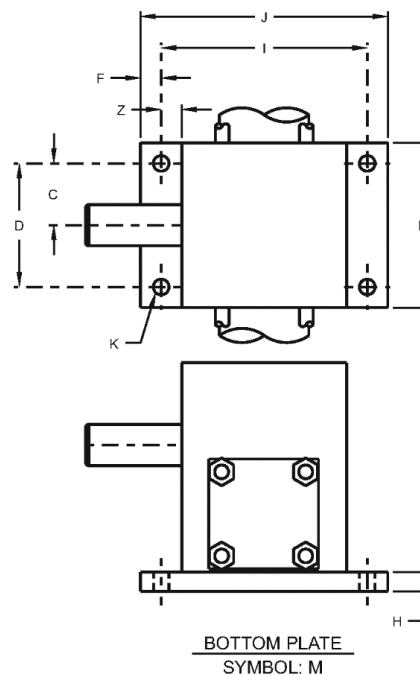

## TIE ROD ACTUATOR VENT PORTS

Actuators with washdown (J) option require vent ports to avoid pressure buildup inside body. Vent port should be plumbed to a clean, dry area. Single rack actuators have vent on the side of the body as shown. For dual rack actuators, select the desired vent port location and add it to the model number following the J. E.G.: A22-90-TC-S5-1/8-1-J1

### SINGLE RACK STANDARD VENT PORT LOCATION

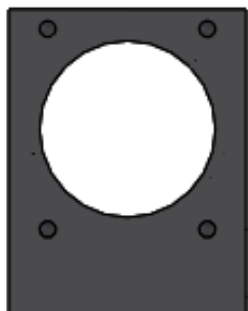

FRONT

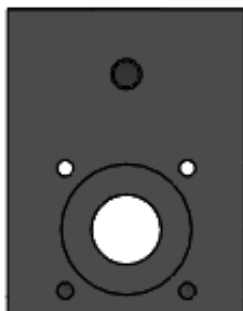

RIGHT

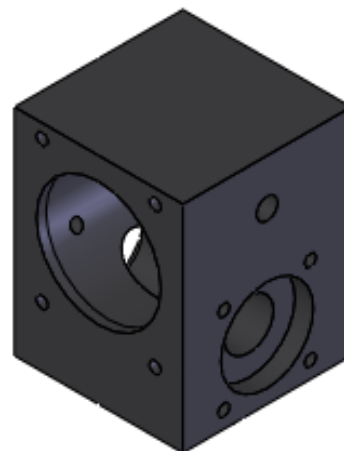

### DUAL RACK VENT PORT LOCATIONS

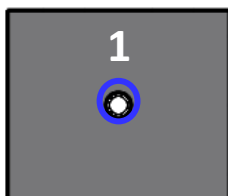

TOP

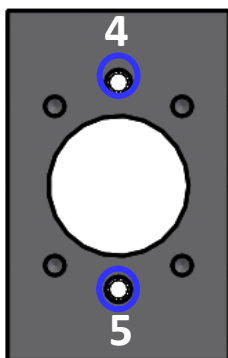

FRONT

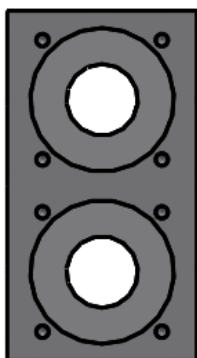

RIGHT

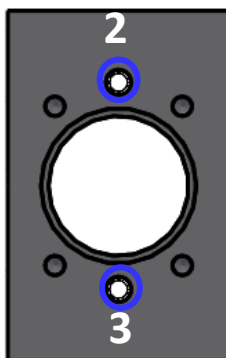

REAR

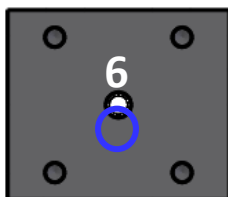
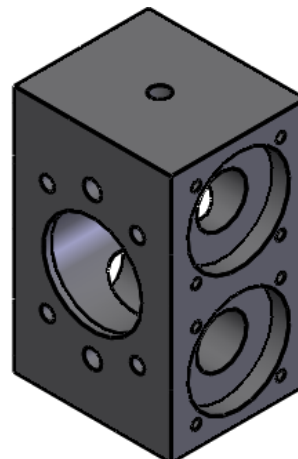

BOTTOM

## MAGNETIC POSITION SENSORS FOR ROTOMATION ACTUATORS

Rotomation installs and tests each magnetic switch on the actuator being sold. The switch is set to the correct position (may require adjustment if the actuator is equipped with rotation adjusters.) This saves the customer assembly time, ordering effort, and errors, and ensures that the unit received will work properly out of the box. Replacement switches are also tested at Rotomation on an actuator prior to shipping.

All switches have LED indicators for easy setup and troubleshooting.

- Be sure to connect properly and do not exceed maximum ratings; either will damage the switch
- Reed switch has built-in surge protection, others do not
- Switches and cables are rated NEMA 6, resistant to moisture, dust, and oil.
- Because Rotomation has tested each switch and has no control over how it might be connected in the field, switches are not covered by warranty.

**NOTE: G switch does not work on standard products, requires special construction**

L = 9' LEAD    C = 6" PIGTAIL W/ 8mm CONNECTOR

|                   | SWITCHES FOR TIE ROD UNITS |           |                   | SWITCHES FOR A032, A752, & AL75 |           |
|-------------------|----------------------------|-----------|-------------------|---------------------------------|-----------|
|                   | R                          | S         | G                 | R                               | S         |
| SWITCHING VOLTAGE | 6-24 VDC                   | 6-24 VDC  | 5-120 VAC/VDC     | 5-28 VDC                        | 5-28 VDC  |
| SWITCHING CURRENT | .3A, MAX                   | .3A, MAX  | .5A, MAX, 005 MIN | .2A, MAX                        | .2A, MAX  |
| SWITCHING POWER   | 7.2W, MAX                  | 7.2W, MAX | 10W, MAX          | 4.8W, MAX                       | 4.8W, MAX |
| VOLTAGE DROP      | .5V                        | .5V       | 3.5V              | 1.0V, MAX                       | 1.0V, MAX |

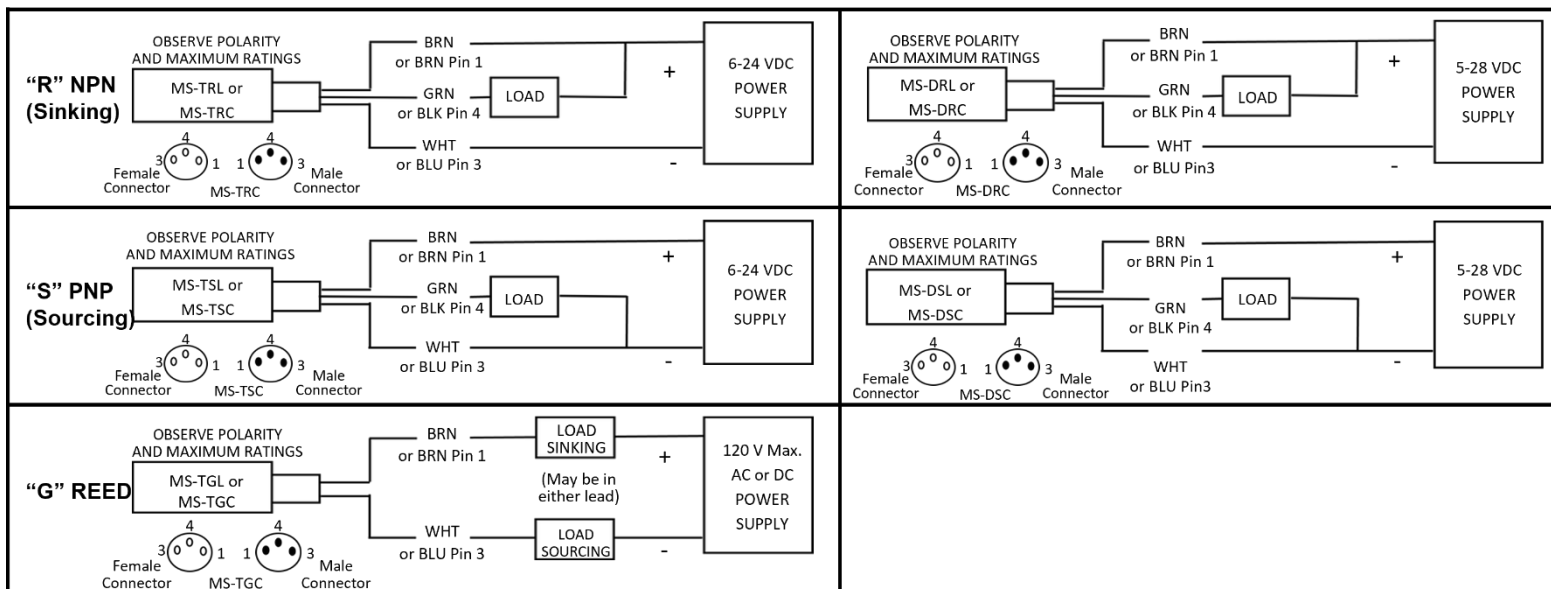

## OTHER SIGNAL OPTIONS

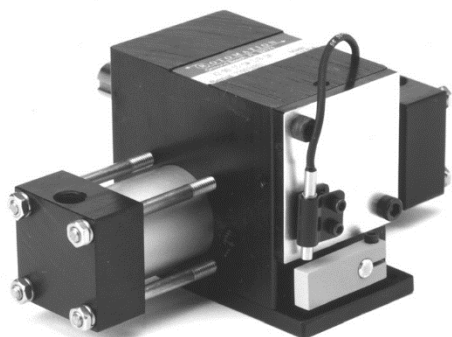

### INDEXING ACTUATOR EXTENDED PAWL SHAFT

The shaft rotates 7 degrees at index and reset. Customer can fabricate and install arm and switch, prox detector, or pilot valve for signaling.

[View The Tech Guide](#)

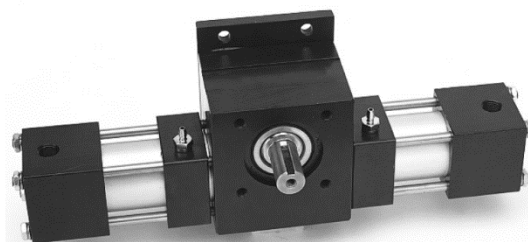

### SIGNAL PORT

For use in explosive or other atmospheres or with air logic controls. Ports provide line pressure signal at the ends of rotation to actuate external devices. Fixed position, not adjustable.

See [auto-run setup and operation](#)

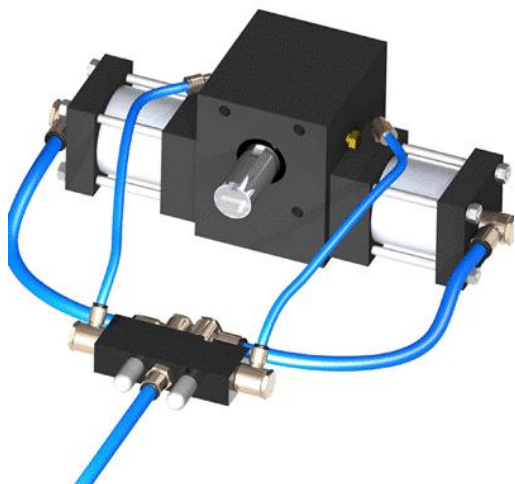

### AUTO-RUN SETUP & OPERATION

Pneumatic **signal** ports can be used to drive pilot-operated valves or other control elements for auto-cycle or other functions. This operation is excellent for applications requiring very simple automation or if the actuator is to operate in hazardous areas such as explosive environments, where intrinsically-safe components are required.

**Signal** ports are additional components that are mounted onto an actuator's cylinders and are available as a special **option** for any Rotomation tie rod actuator, including rotary, indexing, stepping, pick-and-place, or nitpicker actuators. Make sure to specify this during the actuator configuration.

Please note that you may need additional plumbing components to set up auto-run operation and the 4-way valves need to be pilot-operated.

## MATCH YOUR LOAD WITH SHAFT OPTIONS FOR ROTOMATION ACTUATORS

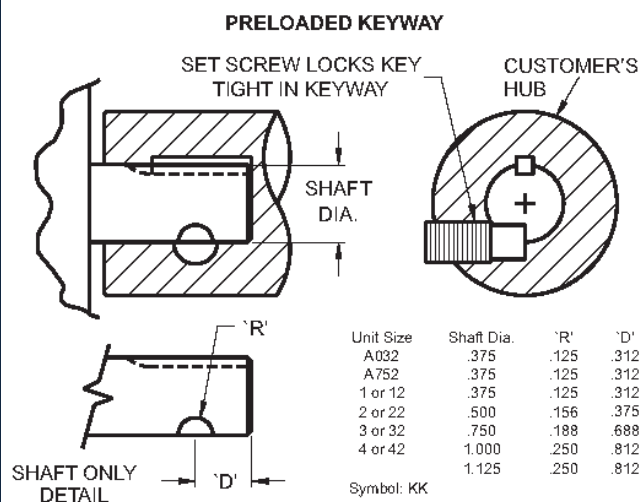

### SPECIAL SHAFTS

Designing the shaft to fit the application can save parts, improve accuracy, reduce space requirements, or add features. Rotomation actuators all have heavy-duty ball bearings and are manufactured to very close tolerances, so the actuator can often function as the complete bearing assembly for the product. Simply providing an extra-long shaft might eliminate a coupling, a pair of pillow blocks, and a shaft.

Other possibilities include:

- Holes for air lines, shafts, cables, etc.
- Machined shapes for special couplings or functions
- Metric sizes
- Hollow shafts with internal splines or other features
- Collet spindles

Rotomation rotary actuators have one-piece pinion shafts of heat-treated alloy steel for impact strength and wear resistance. In most cases, the bearings are oversized, so the standard shaft is turned down as it exits the bearing. We stock blanks at full bearing diameter and extra long projection in both directions, giving a large envelope in which to create a custom shaft without impacting strength or delivery.

Indexer shafts cannot be made a larger diameter than the standard, but they can be made to any length.

For a special shaft, please include a sketch or complete description, including diameter, projection, keyway, and/or other features. If desired, we can incorporate these features into a solid model of the actuator for your customer to fit into their CAD assembly.

### HOLLOW SHAFT

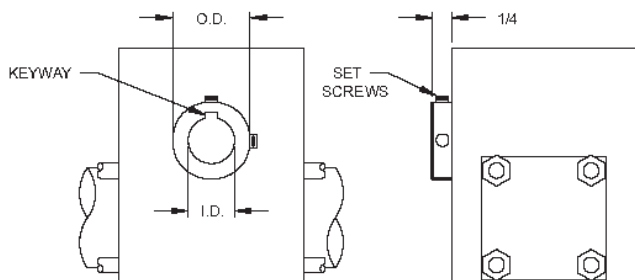

| Unit            | Shaft Symbol | Shaft I.D.  | Keyway      | Shaft O.D. | STD. BRG. | Set Screw |
|-----------------|--------------|-------------|-------------|------------|-----------|-----------|
| A1, A12, & A752 | HS37         | .3755/.3765 | 3/32 x 3/64 | .625       | PLAIN     | 8-32      |
| A2, A22         | HS37         | .3755/.3765 | 3/32 x 3/64 | .750       | BALL      | 8-32      |
| A3, A32         | HS75         | .751/.752   | .187 x 3/32 | 1.378      | BALL      | 10-32     |
|                 | HS62         | .626/.627   | .187 x 3/32 | 1.378      | BALL      | 10-32     |
| A4, A42         | HS75         | .751/.752   | .187 x 3/32 | 1.378      | BALL      | 10-32     |

## SHAFT MOUNTING ADAPTERS FOR ROTOMATION ACTUATORS

[Rotomation shaft mounting adapters \(SMA\)](#) are designed specifically to provide our customers a simple, accurate way to adapt their load to our actuators (shown in the Part Number table to the right of the Part Number table). Our SMAs are available with standard mounting hole patterns ('W' option) or blank ('N' option) for easy customization in your own shop or to your specification in our CNC machine shop. They are made of clear anodized aluminum alloy and come with all necessary hardware. A reference bore on its top face, concentric with its shaft bore, makes customization an easy task. We install them onto our actuators if ordered together for shipping. Optional male or female pilots, accurately machined to your specified diameter, make it easy to install your tooling exactly on the center of rotation.

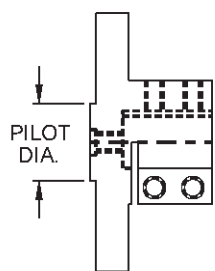
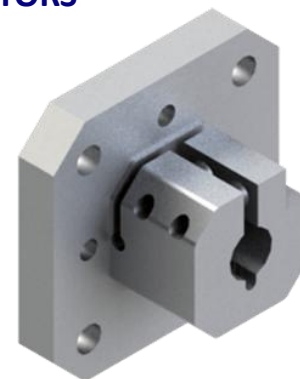

MALE PILOT OPTION

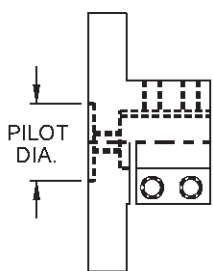

FEMALE PILOT OPTION

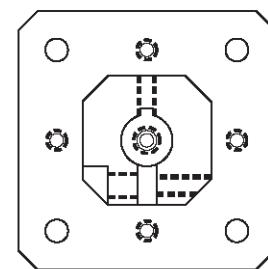
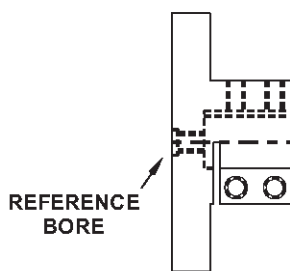

### 2025 SHAFT MOUNT ADAPTER ORDERING INFORMATION

EXAMPLE:

SMA - 50 - W -

SIZE

| SHAFT DIA. | SYMBOL |
|------------|--------|
| 0.375      | 37     |
| 0.500      | 50     |
| 0.750      | 75     |
| 1.000      | 10     |
| 1.125      | 11     |

HOLES

| HOLES                | SYMBOL                         |
|----------------------|--------------------------------|
| SEE CATALOG          | W                              |
| CENTER HOLE ONLY     | N                              |
| USER SPECIFIED HOLES | SXXX FOR SPECIAL DRILL PATTERN |

PILOT

| PILOT               | SYMBOL                                   |
|---------------------|--|
| REFERENCE BORE ONLY | LEAVE BLANK                              |
| MALE PILOT          | M X.XXX WHERE X.XXX IS PILOT DIA, INCHES |
| FEMALE PILOT        | F X.XXX WHERE X.XXX IS PILOT DIA, INCHES |
| TOLERANCES          |  |
| MALE                | -0.002"                                  |
| FEMALE              | +0.002"                                  |

#### NOTES:

1. Material: Clear anodized aluminum.
2. User specified holes: Send drawing. The factory will assign a number XXX.
3. Adapters are stocked with no holes and with holes as shown. Special hole patterns and pilots are normally added after anodize and will expose bare aluminum.
4. Keyway is aligned with the sides of the plate. Reference bore "R" is concentric with a shaft bore within .001 TIR.

## EXTREME ENVIRONMENT/PROTECTION OPTIONS FOR ROTOMATION ACTUATORS

### Washdown “J” Option

For applications where the actuator will be exposed to fluids, corrosive materials, or excessive dust, we offer our washdown (J) option in the following products and configurations. The J option includes sealing of any port of entry into the actuator, stainless steel shafts in rotary actuators/nickel or chrome plated shafts in indexing actuators, and all exposed hardware in stainless steel. A body vent port will be added to rotary actuators. Position of port to be specified by customer as a digit following J, eg. **J1**. Please request vent port location guide for more information. Vent should be plumbed to a clean, dry area to allow the product to breathe without ingesting contaminants.

| ACTUATOR                               | STANDARD SHAFT SEALS                             | STANDARD WASHDOWN SHAFT SEALS (OPTION J) | OPTIONAL WASHDOWN SEALS (OPTIONS V + J)       |
|--|--|--|---|
| AL75                                   | Standard sealed ball bearings (nitrile)          | Nitrile O-ring in PET plain bearing      | Fluorocarbon O ring in PET plain bearing      |
| A032, A752, A01, A1, A12, S1, PA01, S4 | Standard sealed ball bearings (nitrile)          | Not Available                            | Not Available                                 |
| A2, A22, A3, A32, A4, A42, S3, S32     | Standard sealed ball bearings (nitrile)          | PTFE shaft seals and nitrile O-rings     | PTFE shaft seals and fluorocarbon O-rings     |
| S2, X1, X2, X12, X3, X32, X4, X42      | Nitrile shaft seals                              | Nitrile shaft seals                      | PTFE shaft seals                              |
| PA2, PA22                              | Standard sealed ball bearings, nitrile rod wiper | Enclosed ball bearing, nitrile rod wiper | Enclosed ball bearing, fluorocarbon rod wiper |

**STAINLESS STEEL CONSTRUCTION:** For food processing or other extreme environments, all external components except indexer shaft can be fabricated of specified stainless alloys.



### A42 Stainless Steel Rotary Actuator

The reliability and durability of these units largely eliminate the remove-and-replace production interruptions needed for units with less chemical resistance. We can produce just about any of our actuators in a suitable stainless alloy upon request. When nothing else will hold up, your customers will save money going with stainless steel.

**FLUOROCARBON SEALS:** Does not include shaft/bearing seals except as noted above.

**SURFACE TREATMENT:** For aggressive environments, electroless nickel or hard anodized aluminum, both with or without PTFE are available on special order.

**PURGE OR VENT PORTS:** Standard on indexers, optional others for clean room, explosive, or washdown environments

**SPECIAL DUTY GREASE:** Internal lubrication of food grade, synthetic, or Krytox® grease. Available by request on any product.

### – OTHER SPECIAL SERVICE OPTIONS –

**HIGH CYCLE LIFE (HEAVY DUTY) CONSTRUCTION:** Includes PTFE piston wear rings on size 4, acetal pistons on sizes 2 and 3 long life, carboxylated piston seals (unless V or T option is ordered.)

Option **A** has hard coated ID aluminum cylinder tubes, option **K** has honed and chromed ID/powder coat OD steel cylinders, not available on size 3 actuators. O rings at inner ends of cylinders. K option (steel cylinders) cannot be combined with magnetic switches.

**OIL SERVICE SEALS (PRETENSIONED):** Recommended to minimize leakage, increases breakaway pressure. Option **T** available on most products.

**HYDRAULIC SERVICE:** Extra long pistons, oil service seals, and/or high strength tie rods. Option **HP** available on 1-2” bore tie rod rotary actuators.

## REPAIR SERVICES & PRODUCT WARRANTY FOR ROTOMATION ACTUATORS

### REPAIR SERVICES

All returns require an RMA issued by Rotomation. If Rotomation agrees that it is likely that the repair will be done under warranty, no purchase order is required. Otherwise, the distributor should issue a purchase order for the unit to be evaluated for repair. Requests for expedited service should be made at that time.

If the problem is covered by warranty, Rotomation will promptly repair and return the unit with no-charge billing. Otherwise, the unit will be evaluated within the agreed-upon schedule and a quotation to repair will be supplied. The estimated price will include the evaluation and repair charges from the chart on the right, plus list prices for seals and other parts as required to return the product to essentially new functionality. Cosmetic damage will not be repaired.

If the customer chooses not to proceed with the repair, or if thirty days pass after the quote without an order, the distributor will be billed for the evaluation charge accordingly. Upon request, the unit will be returned disassembled at the owner's expense.

### ROTOMATION PRODUCT WARRANTY

Rotomation products are warranted to be free of defects in materials and workmanship for a period of two years from the date of shipment. This warranty does not cover products determined by Rotomation to have been subject to misuse, abnormal conditions, overload, or misapplication, or that have been altered or improperly repaired after shipment.

Electronic sensors are tested by Rotomation prior to shipment but are not covered by this warranty.

Products considered to be defective must be returned to Rotomation with transportation paid by the buyer, clearly marked with an RMA number issued by Rotomation. The sole remedy to the buyer is the repair or replacement of the product or refund of its purchase price, at Rotomation's discretion.

This warranty as stated is the only liability of Rotomation to the buyer or its customers. Rotomation gives no other warranty, express or implied, regarding merchantability or fitness for a particular use. Rotomation will not be liable for any consequential or indirect damages of any kind suffered by the buyer or third party.

Please contact our office with any questions:

Phone: 386-676-6377

Email: [sales@rotomation.com](mailto:sales@rotomation.com)



# 2026 PRODUCT GUIDE



*"We're not just building machines; we're  
architecting a future where efficiency fuels  
creativity and innovation knows no bounds.  
Automation is the engine of progress."  
- Norman Lane, President*