

NOTE:
ORDER PARTS BY PART NAME AND COMPLETE UNIT SPECIFICATION NUMBER OR SERIAL NUMBER.

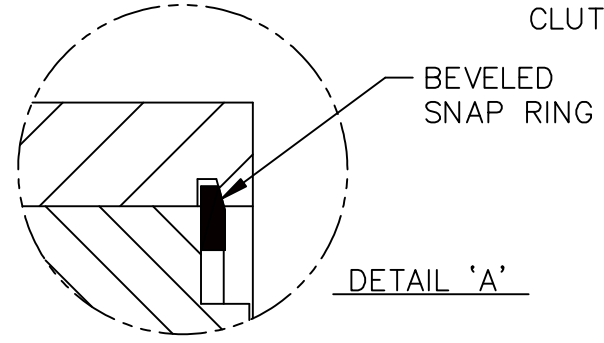
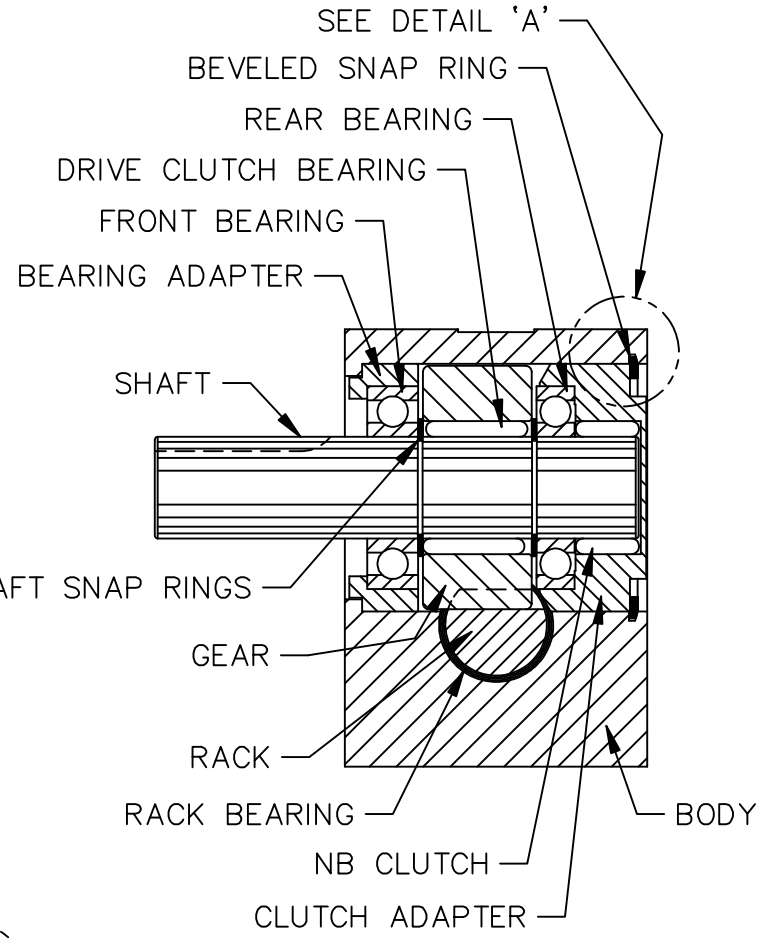

ROTOMATION

11 SUNSHINE BLVD. ORMOND BEACH, FL. 32174

S4 STEPPER PARTS LOCATION

DWG. NO. A4-084