

SEAL REPAIR KITS AND SEAL OPTIONS

PART NUMBERS FOR SEAL REPAIR KITS



EXAMPLES:
 SEAL KIT FOR X3-90-CW-S75-3C2-3RL-1/4-1 = SRK-X3-C
 SEAL KIT FOR X3-180-CCW-S10-2F1-1/4 = SRK-X3-F
 SEAL KIT FOR SPECIAL, SUCH AS X3-B004 = SRK-X3-B004
 IF PART NUMBER IS NOT KNOWN, PROVIDE UNIT SERIAL NUMBER FROM LABEL OR STAMPED INTO BODY UNDER LABEL.

OPERATION-INDEXING ACTUATOR

- At end of drive stroke (shown), shaft is locked against forward motion by pawl in ratchet and against rearward motion by applied torque and non-return clutch. Do all position sensitive work operations in this locked condition, with pressure applied in drive direction.
- To reset for the next drive operation, apply pressure to reset (left) cylinder. Rack moves to right, driving gear and cam but not shaft. At end of stroke, cam lifts pawl. Allow time in operating cycle to complete reset motion before initiating drive. Bumper will reduce reset impact. Flow control or cushion effective; do not slow beyond cycle time limit. With unit in reset, external torque can move shaft in forward direction; use brake if required.
- To drive to next index, apply pressure to opposite (right) port. Rack moves to left, driving gear and cam, shaft and ratchet to next index. Index stop is abrupt-metal to metal. It can dislodge work pieces or even break shaft. Regulate drive speed and impact by flow control of exhausting (left) cylinder. **DO NOT OPERATE WITH AN INERTIAL LOAD WITHOUT SPEED (FLOW) CONTROL. ARRANGE CONTROL LOGIC TO SHUT DOWN IN LOCKED POSITION TO AVOID UNCONTROLLED ROTATION AT STARTUP.** Cushion reduces drive last 30 deg. but will not retard inertia load. Bumper not applicable.

DRIVE CLUTCH BEARING

Locks gear to shaft in drive direction. Allows gear and cam to spin freely in reset direction

X3 INDEXING ACTUATOR PARTS LOCATION

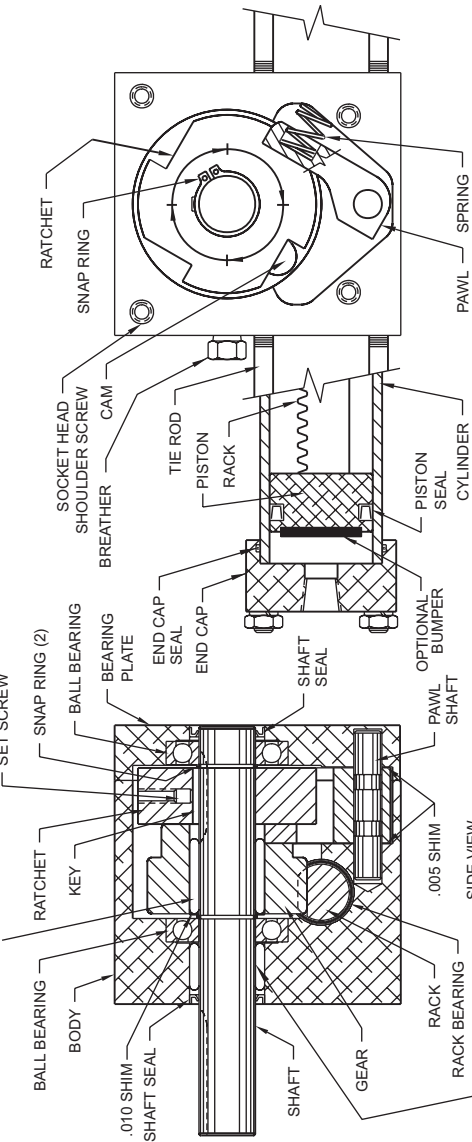

NON-RETURN CLUTCH
 Locks shaft to body in reverse direction, as in reset. Allows shaft to rotate freely in drive direction.

NOTE:
 ORDER PARTS BY PART NAME AND COMPLETE PART NUMBER OR SERIAL NUMBER.

REAR VIEW
 BEARING PLATE & BALL BEARING REMOVED
 CCW INDEXING ACTUATOR SHOWN AT END OF DRIVE STROKE WITH SHAFT LOCKED
 CW INDEXING ACTUATOR IS MIRROR IMAGE



11 Sunshine Blvd. Ormond Beach, Fl. 32174 Phone: 386/676-6377 Fax: 386/676-6379
 Email: sales@rotomation.com Website: www.rotomation.com

X3 INDEXING ACTUATOR INSTALLATION AND SETUP

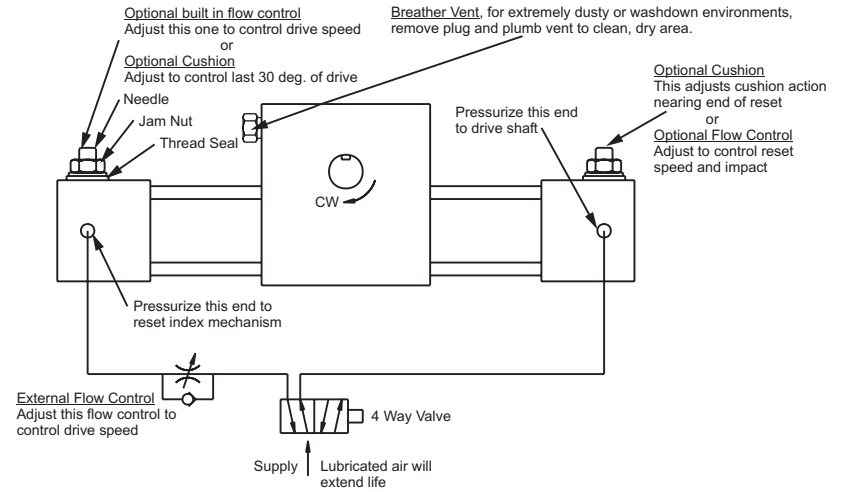

CW INDEXING ACTUATOR SHOWN-CCW UNIT IS MIRROR IMAGE.
 REVERSE OPTION LOCATIONS AND OPERATIONS FOR CCW INDEXING ACTUATOR.

ADJUST IN FOLLOWING ORDER:

Skip options which your actuator does not have. Speed adjustment is made with flow controls, built in ("F" option) or external (not supplied by Rotomation).

To adjust built in controls:

To adjust drive speed (shaft rotation speed) or speed of reset,

- Loosen jam nut.
- Tighten needle to reduce speed, loosen to increase speed. Make small adjustments.
- Tighten jam nut while holding needle steady.

To adjust cushion ("C" option) on reset or drive:

- Loosen jam nut.
- Tighten needle to increase stiffness of cushion, loosen to decrease. Do not close needle.
- Tighten jam nut while holding needle steady.

To adjust magnetic switch "G", "R" or "S" option.

- DISABLE AUTOMATIC CONTROL. KEEP CLEAR OF SHAFT AND SHAFT MOUNTED PARTS!
- Apply voltage to switch only; place switch at end of cylinder sensing drive as shown.
- Manually valve system to drive unit to rotate shaft to index point.
- With clamp loose, move switch sensing drive toward body until LED glows, clamp.
- Valve system to drive unit to reset.
- With clamp loose, move switch sensing reset toward body until LED glows, clamp.
- Cycle to check operating points, adjust as required.

INDEXING ACTUATOR SWITCH PLACEMENT

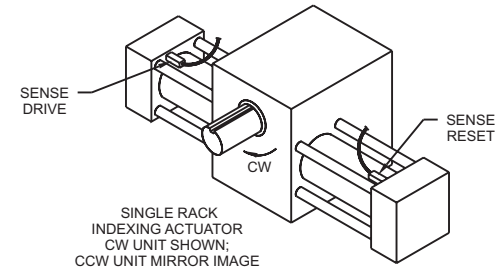

SWITCH LEADS

	OPTION	LEAD
Standard Lead	GL, RL, SL	9', end stripped
Connection option	GC, RC, SC	6" pigtail with male connector

EXTENSION CABLES (PURCHASE SEPARATELY)

PART NUMBER	DESCRIPTION
CC2	2 m cable, female connector one end, stripped other end.
CC5	5 m cable, female connector one end, stripped other end.

- KEEP MAGNETIC MATERIAL AWAY -

SENSING

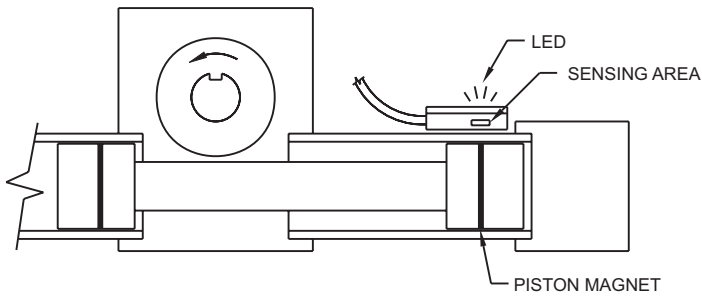

APPROACHING PISTON MAGNET ACTIVATES SENSOR, OPERATES SWITCH AND LED.
PLACE SWITCH AS CLOSE AS POSSIBLE TO END CAP FOR CORRECT OPERATING POSITION.

SWITCH MOUNTING

TIE ROD CLAMP

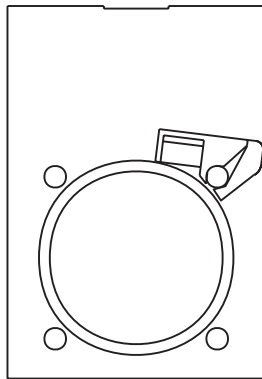

SERIES X4

STRAP CLAMP

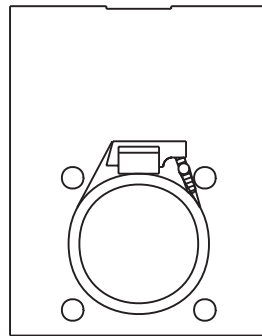

SERIES X3

**TIGHTEN STRAP CLAMP
TO HOLD SWITCH STABLE.
DO NOT DISTORT SWITCH CASE.**

ROTOMATION REED SWITCH - OPTION G

DESCRIPTION AND RATING

Reed switch with LED & Surge Protection, normally open
 Switching voltage 5-120 VAC/VDC
 Switching current .5 a, max., .005 min.
 Switching power 10 w, max.
 Voltage drop 3.5 V
 Temperature range -30 to +80C
 Environment Resistant to moisture, dust, oil

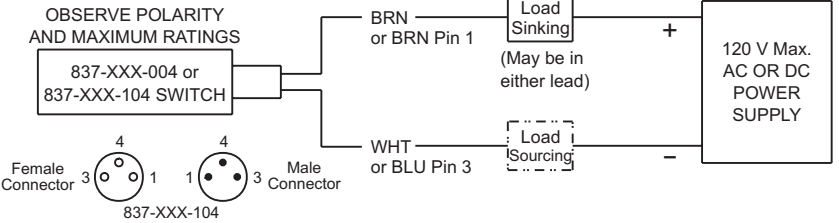

ROTOMATION SINKING (NPN) SWITCH - OPTION R

DESCRIPTION AND RATING

NO, sinking (NPN), LED
 Switching voltage 6 to 24 VDC
 Switching current .5 a, max.
 Switching power 12 w, max.
 Voltage drop .5 V
 Temperature range -30 to +80C
 Environment Resistant to moisture, dust, oil

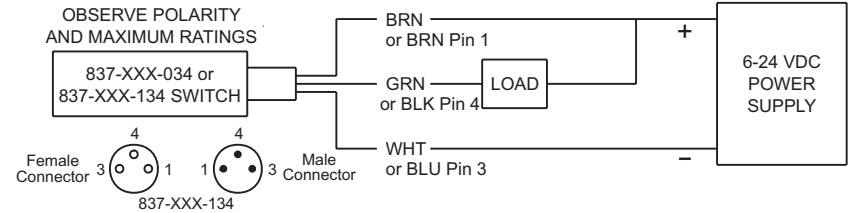

ROTOMATION SOURCING (PNP) SWITCH - OPTION S

DESCRIPTION AND RATING

NO, sourcing (PNP), LED
 Switching voltage 6 to 24 VDC
 Switching current .5 a, max.
 Switching power 12 w, max.
 Voltage drop .5 V
 Temperature range -30 to +80C
 Environment Resistant to moisture, dust, oil

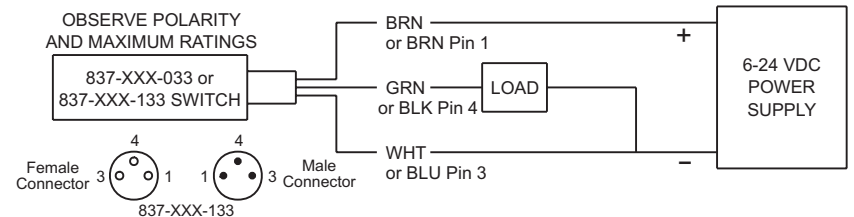

ROTOMATION TESTS ALL SWITCHES FOR PROPER FUNCTION BEFORE SHIPMENT AND CANNOT REPLACE THEREAFTER. SWITCHES OF OTHER MANUFACTURE HAVE NO GUARANTEE OF COMPATIBLE PERFORMANCE BY ROTOMATION, INC.